

dlb

THE SOUND ENGINEERING MAGAZINE

MAY 1975 \$1.00

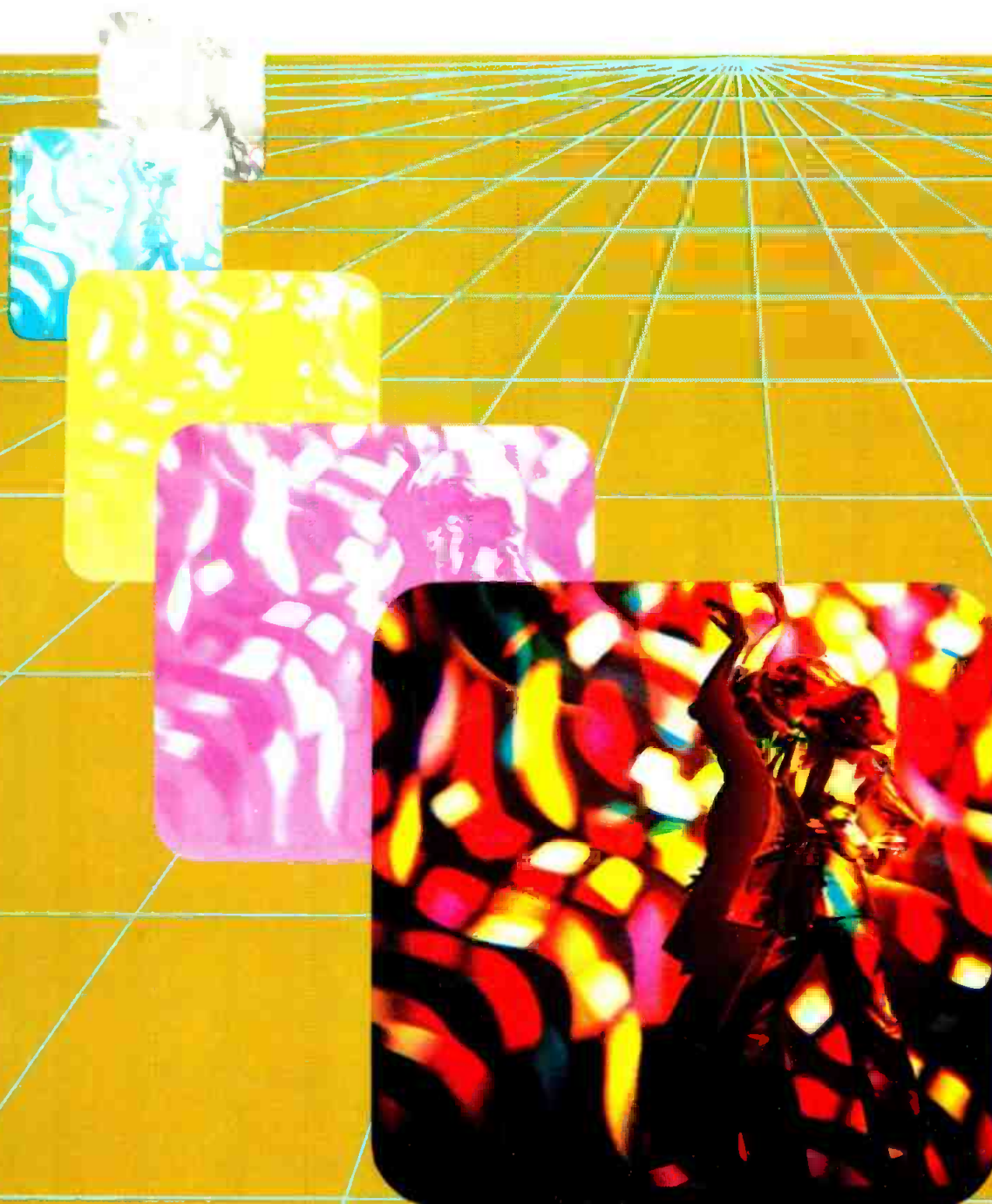

IN THIS ISSUE:

- How to Make a Simple High-Speed Tape Duplicator
- A Systematic Approach to Wiring Connectors
- Motion Picture Sync Systems

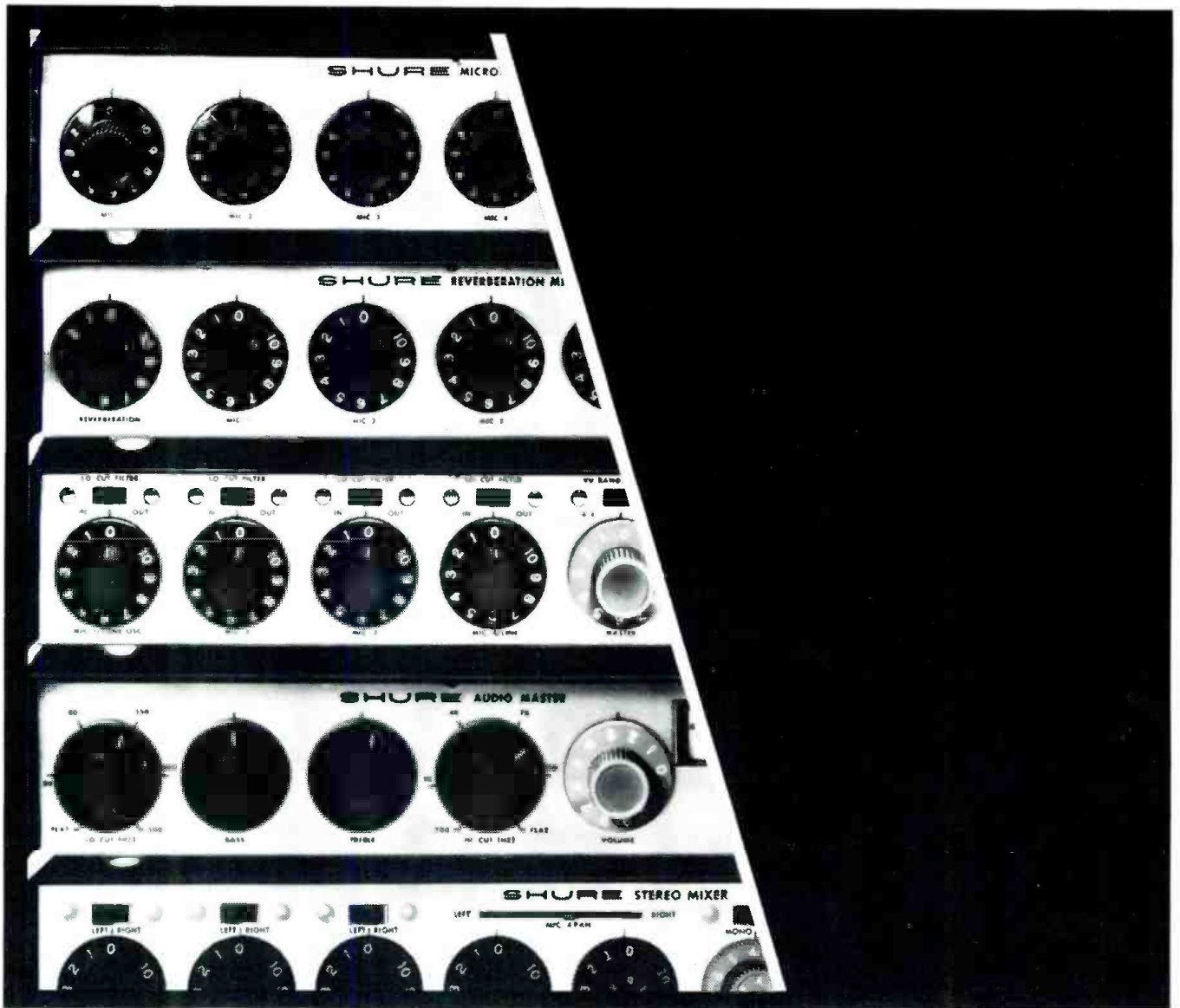

Panel full of miracles.



Shure mixers, audio level controllers, and feedback controllers are all designed to deliver more audio control, more features, and more performance dollar for dollar than any other components with similar audio features. Their compact size and modular "stackable" design mean they can be easily combined in various configurations in even the smallest spaces. And they're versatile—their input-output flexibility equips them for an extremely wide range of audio applications, giving you control you never thought possible without bulky, expensive installations. You can easily put together a system that's exactly right for your precise needs without putting extra dollars into built-in features you really don't need. For the details on our entire line of miracle workers, write:

Shure Brothers Inc.
 222 Hartrey Ave., Evanston, IL 60204
 In Canada: A. C. Simmonds & Sons Limited



Manufacturers of high fidelity components, microphones, sound systems and related circuitry.

Circle 10 on Reader Service Card

www.americanradiohistory.com

coming
next
month

● COVERS AUDIO BAND IN ONE SWEEP, by James Davidson, describes how a 555 timer can be adapted to create a square-wave generator which covers 20-20,000 Hz with no band switching.

● Josef Dorner discusses the pros and cons of tape speeds in his WHY USE 15-IPS TAPE SPEED?

● Stephen Lampen visits big and small recording studios and tells us HOW AUDIO IS DOING IN SAN FRANCISCO.

Of Special Interest To Our Readers

During the past eight years, we have published a number of outstanding articles dealing with fundamentals and basic techniques that form the foundation of audio principles and practices. Since many of the issues where these articles originally appeared are no longer available (except on microfilm) and in response to the many requests from new readers for this material, we are pleased to announce that a reprinting program of these articles has been initiated starting in this issue. The series will be entitled "The Best of db."

The first reprint is High Quality Monitor Loudspeakers by Harry F. Olson which originally appeared in our December 1967 issue. It will be followed by many other worthwhile articles as space permits.

We hope you find them informative and helpful in your particular area of audio specialization. Many of our readers may wish to clip them for their personal reference files since they deal with basics that are unaffected by time and are as meaningful today as when they first appeared.

We always welcome your comments and suggestions.

about
the
cover

● The unusual cover effect has been created by our art director, Bob Laurie, from a photograph kindly supplied by Meteor Lighting Co., Syosset, N.Y., manufacturers of a wide variety of discotheque lighting effects.

db

THE SOUND ENGINEERING MAGAZINE

MAY 1975, VOLUME 9, NUMBER 5

18	AUDIO BOOMS IN DISCOTHEQUES Slavko Rebec
21	HIGH-QUALITY MONITOR LOUDSPEAKERS (Reprint) Harry F. Olson
32	MOTION PICTURE SYNC SYSTEMS Douglas R. Kaye
36	db VISITS AUDIOMATIC IN PARIS Larry Zide
38	A SYSTEMATIC APPROACH TO WIRING CONNECTORS Doug Rygalo
40	THE LONDON AES CONVENTION John Woram
44	A SIMPLE HIGH-QUALITY HIGH-SPEED TAPE DUPLICATOR Bob S. White
2	INDEX OF ADVERTISERS
4	LETTERS
8	CALENDAR
10	THEORY AND PRACTICE Norman H. Crowhurst
14	SOUND WITH IMAGES Martin Dickstein
25	NEW PRODUCTS AND SERVICES
50	CLASSIFIED
52	PEOPLE, PLACES, HAPPENINGS

db is listed in Current Contents: Engineering and Technology

Robert Bach PUBLISHER Alex Porianda
MANAGING EDITOR

Larry Zide EDITOR John Woram
ASSOCIATE EDITOR

Bob Laurie ART DIRECTOR Hazel Krantz
COPY EDITOR

Eloise Beach CIRCULATION MANAGER Ann Russell
PRODUCTION

GRAPHICS Crescent Art Service

db, the Sound Engineering Magazine is published monthly by Sagamore Publishing Company, Inc. Entire contents copyright © 1975 by Sagamore Publishing Co., Inc., 1120 Old Country Road, Plainview, L.I., N.Y. 11803. Telephone (516) 433 6530. db is published for those individuals and firms in professional audio recording, broadcast, audio-visual, sound reinforcement, consultants, video recording, film sound, etc. Application should be made on the subscription form in the rear of each issue. Subscriptions are \$6.00 per year (\$12.00 per year outside U. S. Possessions, Canada, and Mexico) in U. S. funds. Single copies are \$1.00 each. Controlled Circulation postage paid at Harrisburg, Pa. 17105. Editorial, Publishing, and Sales Offices: 1120 Old Country Road, Plainview, New York 11803. Postmaster: Form 3579 should be sent to above address.

db May 1975 1



Your connection to the musician

Today's studio techniques require careful control of both noise and instrument isolation. The MXR Noise Gate/Line Driver "cleans up" a signal plagued by noise and hum, and provides a natural interface to a studio mic line.

The Noise Gate threshold level is variable over a wide range, enabling it to be used in a wide variety of applications. The Line Driver function provides an ideal interface to any studio console or mixing console mic line, allowing a direct tap from an instrument and ensuring complete isolation from other instruments.

The MXR Noise Gate/Line Driver is equipped with a three pin XLR connector, from which a low impedance signal capable of driving a 600 Kohms line may be obtained with no insertion loss.

MXR Innovations
Musical Products Group
 P.O. Box 722
 Rochester, N.Y. 14603

Circle 12 on Reader Service Card

advertisers index

Amber Electro Design	12
Audio by Zimet	6
Audio Design	8
Audionics	8
Automated Processes	cover 4
BGW	14
Broadcast Electronics	30
Cetec Audio	39
Electro-Voice	26
Garner Industries	29
Gately	43
Gotham	27, 31
Inovonics	28
Interface Electronics	10
London Company	16
Martin Audio	26
Micmix Audio	42
MXR Innovations	2, 25, 27, 29
3-M Pro-Audio	13
Orban/Parasound	30
Otari	5
Philips Audio AKG	7
Polyline	31
Ramko Research	3
RCA	28
Rupert Neve	19
Sescom	6
Shure Brothers	cover 2
Soundcraftsmen	4
Southwest Technical Products	20
Spectra-Sonics	15
Standard Tape Lab	4
Sunn Musical Equipment	9
TEAC Corp. of America	cover 3
Tektronix	11
UREI	20
Westlake Audio	47
Willi Studer	17
Woram Associates	6



sales offices

THE SOUND ENGINEERING MAGAZINE

New York

1120 Old Country Rd.
 Plainview, N.Y. 11803 516-433-6530

Roy McDonald Associates, Inc.

Dallas

Stemmons Tower West, Suite 714
 Dallas, Texas 75207 214-637-2444

Denver

3540 South Poplar St.
 Denver, Colo. 80237 303-758-3325

Houston

3130 Southwest Freeway
 Houston, Tex. 77006 713-529-6711

Los Angeles

500 S. Virgil, Suite 360
 Los Angeles, Cal. 90020 213-381-6106

Portland

2035 S. W. 58th Ave.
 Portland, Ore. 97221 503-292-8521

San Francisco

Suite 265, 5801 Christie Ave.
 Emeryville, Cal. 94608 415-653-2122

Our new E series audio equipment will improve your sound and cut your costs . . . or your money back!



**TURNTABLE
PREAMPS**



**MIC & LINE
AMPLIFIERS**



AUDIO DISTRIBUTION AMPLIFIERS

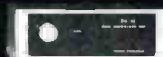

AUDIO CONSOLES & CONTROLLERS



**STUDIO MONITOR
AMPLIFIERS**



**REMOTE POWER
CONTROLLERS**

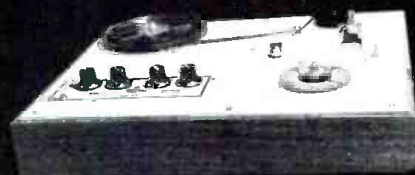

**AUTOMATIC TAPE CARTRIDGE
& CASSETTE LOADERS**

TEN DAY FREE EVALUATION AND 2 YEAR GUARANTEE INSURE YOUR UNCOMPROMISED SATISFACTION

TURNTABLE PREAMPS

Preamps costing almost 3 times more will not compare with these units. RIAA/NAB equalized ± 1 db, 0.5MV sensitivity at 1KHz for $+4$ dbm out, balanced outputs, -75 db s/n at 10mv in, 0.05% distortion, $+21$ dbm max. out. Internal power supply.

MP-8E Mono \$86 SP-8E Stereo \$137

MIC & LINE AMPLIFIERS

Dual function and superb performance. Inputs for mic and line, ± 0.5 db response 10Hz-20KHz, 67db gain on mic channel(s) $+26$ db gain on line inputs. Balanced inputs & outputs, $+21$ dbm out max, 0.1% distortion. Internal power supply.

MLA-1E Mono \$98
MLA-2E Dual Mono/Stereo \$139

AUDIO DISTRIBUTION AMPLIFIERS

From 1 in/6 out to 20 in/80 out in one small package. Whatever your distribution requirements we have an answer. All units meet or exceed the following specifications: Balanced bridging/matching inputs, balanced 600ohm outputs, ± 0.5 db response 10Hz-20KHz, ± 3 db 5Hz-40KHz, 26db gain, $+21$ dbm out. max. capability, 0.1% or less distortion, outputs isolated by 80db, hum and noise 90db down referenced to $+21$ dbm out. Internal power supplies.

DA-6/E Table top. 1 in/6 out. \$131
DA-6R/E Rack mount. 1 in/6 out. \$149
DA-6BR/E Rack mount. 1 in/6 out. Individual level controls for each output. \$165
DA-6RS/E Rack mount. 1 in/6 out stereo or 2 in/12 out mono. \$229
DA-16BR/E Rack mount. 1 in/8 out stereo or 2 in/16 out mono. Individual output level controls, selectable metering & headphone monitoring. \$287
DA-2080/E Rack mount main frame with protected

power supply, metering & headphone monitor. Will accept up to 10 slide in modules. Each module has 2 inputs & 8 outputs. Individual output level controls & selectable meter switch. Up to 20 in/80 out.

DA-2080/E Main Frame \$150
DA-2080/E Modules 2 in/8 out \$135 ea.

AUDIO CONSOLES & CONTROLLERS

Our new series 35 audio controller introduces a new concept in audio mixing. Allows separation of controls from the audio functions. Controls can be placed in any convenient location in the studio, while electronics may be mounted anywhere for easy maintenance & hookup. Remote DC control for completely unaffected audio.

This versatility gives you a custom designed console at a standard production model cost.

Features include; 8 channels, mono, dual channel mono, stereo, dual channel stereo, or combinations; paralleling 2 units for quad, fail safe power supply & plug in interchangeable cards.

Performance specifications are; 0.3% or less distortion, 124dbm equivalent noise on low level channels, approximately 25w power consumption, -70 db crosstalk, balanced bridging/matching inputs & response within ± 2 db 20Hz-20KHz. Series 35 audio controllers start at \$1200.

AUTOMATIC TAPE CARTRIDGE AND CASSETTE LOADERS

So easy to use & accurate that our largest winder competitor has been using one of these to load their own carts.

Eliminates guesswork. Set the dials to the length desired. The exact amount of tape is fed onto the cart or cassette hub and then shuts off automatically. Also has exclusive torque control for proper tape pack on different size hubs. Winds at 30 IPS.

ACL-25/E \$185

Winders also come in higher speed models (ACL-60 series). Same operation as above but winds at 60 IPS. Accepts 14" pancakes.

ACL-60T/E (tone stop only) \$266
ACL-60B/E (Blank tape loader) \$331
ACL-60BT/E (for both prerecorded and blank tape) \$375

STUDIO MONITOR AMPLIFIERS

Exceptional reproduction! Internal muting. ± 2 db response from 20Hz-40KHz. 25w music power, 20w RMS into 8 ohms. Hum & noise 65db below rated outputs.

Distortion less than 0.25% at less than 20w out, 1% or less at 20w. Works into 4-16ohms. Balanced bridging inputs, variable bass contour, internal overload & short circuit protection.

SMA-50/E Table top (mono) \$125
SMA-500/E Rack mount (mono) \$142
SMA-1000/E Rack mount (stereo-40w) \$196

REMOTE POWER CONTROLLERS (DUAL)

Safe, transient free means of controlling 110V/AC. Turntables, on the air lights, etc.

PR-2 (toggle switch on/off) \$39
PR-2B (momentary contact actuation) \$54

Give us a call or write today for further details. You'll be money and performance ahead.

CALL COLLECT — (916) 392-2100

WRITE — 3516-C LaGrande Boulevard
Sacramento, California 95823

RAMKO RESEARCH

Circle 13 on Reader Service Card

www.americanradiohistory.com

EQUALIZATION

by *Soundcraftsmen*

PERFECT tailoring of octave-wide bands ... Infinitely variable adjustment flexibility ...
L.E.D.'s for zero gain monitoring ... Instant re-setting via Computone-Charts

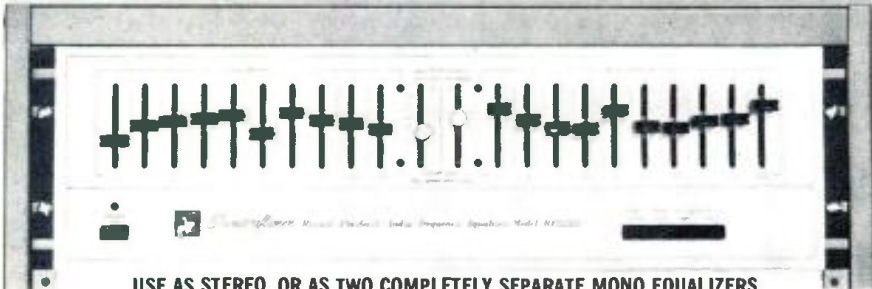

USE AS STEREO, OR AS TWO COMPLETELY SEPARATE MONO EQUALIZERS

RADIO - TV APPLICATIONS • Equalize telephone "talk shows" for voice intelligibility programming • Pre-program tape production for automated or engineered programming • Enhance live and taped broadcasts for optimum frequency balancing • Improve "remote audio-casts" for studio quality performance

RECORDING - STUDIOS • Equalize various instruments for proper recording balance • Compensate for difficult microphone placement • Adjust individual frequency ranges for room acoustic inadequacies

SOUND REINFORCEMENT • Blend voice and instrumental live performances • Eliminate feedback and reduce the possibility of ringing

FEATURES • DISCRETE-OCTAVE EQUALIZATION CONTROL of ten octaves on each channel, ± 12 db each octave • FULL-SPECTRUM LEVEL CONTROL for each channel • AUTOMATIC CONTINUOUS MONITORING by light-emitting diodes for visual warning of overload in output circuits • VISUAL ZERO-GAIN EQUALIZATION BALANCING on music, white noise or pink noise • LINE OR TAPE equalization selector • AUTOMATIC EQUALIZER-DEFEAT when line or tape equalizer is not in use

SPECS • TOROIDAL and ferrit-core inductors • FREQUENCY response: $\pm 1/2$ db from 20-20,480 Hz at zero setting • HARMONIC DISTORTION: Less than .1% THD @ 2 v., Typ: .05% @ 1 v. • IM DISTORTION: Less than .1% @ 2 v., Typ: .05% @ 1 v. • SIGNAL-TO-NOISE RATIO: Better than 90 db @ 2v. input.

For information phone 714-556-6191 **RP2212-600 — \$399.50** includes walnut-grain cabinet or rack mount

Circle 14 on Reader Service Card

You're in Good **COMPANY**

when you use STL magnetic Test Tapes

STL magnetic test tapes are widely used by major recording studios, equipment manufacturers, government and educational agencies throughout the world. The most comprehensive test tapes made they are offered in 1" and 2" sizes as well as flutter tapes and all other formats.

You know your system is in step with the rest of the industry, compatible and interchangeable, when you employ STL tapes, the most accurate reference available.

Write for a free brochure and the dealer in your area.

Distributed exclusively by Taber Manufacturing & Engineering Co.

STL STANDARD TAPE LABORATORY, Inc.
2081 Edison Avenue
San Leandro, CA 94577
(415) 635-3805

Circle 15 on Reader Service Card

db letters

The Editors:

I would like to point out that Marshall King, in his article on the meaning of squared and rooted quantities (db, January 1975), has committed a serious, but common, error which makes his effort more misleading than enlightening, though he provided ample support for the premise of his first line. His error is in asserting that three cows squared are nine cows; they aren't. In the squaring or rooting operation, not only does the magnitude of the quantity change, but so also does the nature of the units of the quantity. Discussing the problem in terms of cows obscures in language the fact that squared fundamental units are still legitimate units, though their meaning is changed. Thus units of distance, such as meters, when squared result in units of area: square meters or hectares. The area of a square three meters on a side is not 3² meters, but 3² meters², or 3² square meters. Milliamp is a unit of electrical current; milliamp squared is not, even though its use is completely valid where appropriate.

Many computations common to audio and acoustics involve unwieldy manipulations of quantities which are often expressed in several different units (microbars, dyne/cm², newton/m², and mm of Hg are all units of pressure, for example). It becomes extremely important to carry out all the manipulations, +, -, X, ÷, powers and roots, integration and differentiation, and others, on the units as well as the magnitudes of all quantities. Not only will you be able to tell whether your answer comes out in acoustic watts or furlongs per fortnight, but keeping track of the units will serve as a check for consistent use of mks, cgs, or other systems of units at the time the quantities are entered. Also, knowing the units to expect in the answer is often an aid to remembering a formula. For example, in looking for an energy you could eliminate dyne/centimeter in favor of dyne.centimeter and know to multiply a force by a distance instead of dividing.

The use of digital calculators has done much to relieve that widespread vacuous feeling that comes at the end of a sliderule thrashing when you wonder where the decimal point went, but it is as important as ever to carry through the units so as to be able to distinguish cows from square cows.

Craig Connally
President, Neotek
Chicago, Ill.

The Sensible Alternative

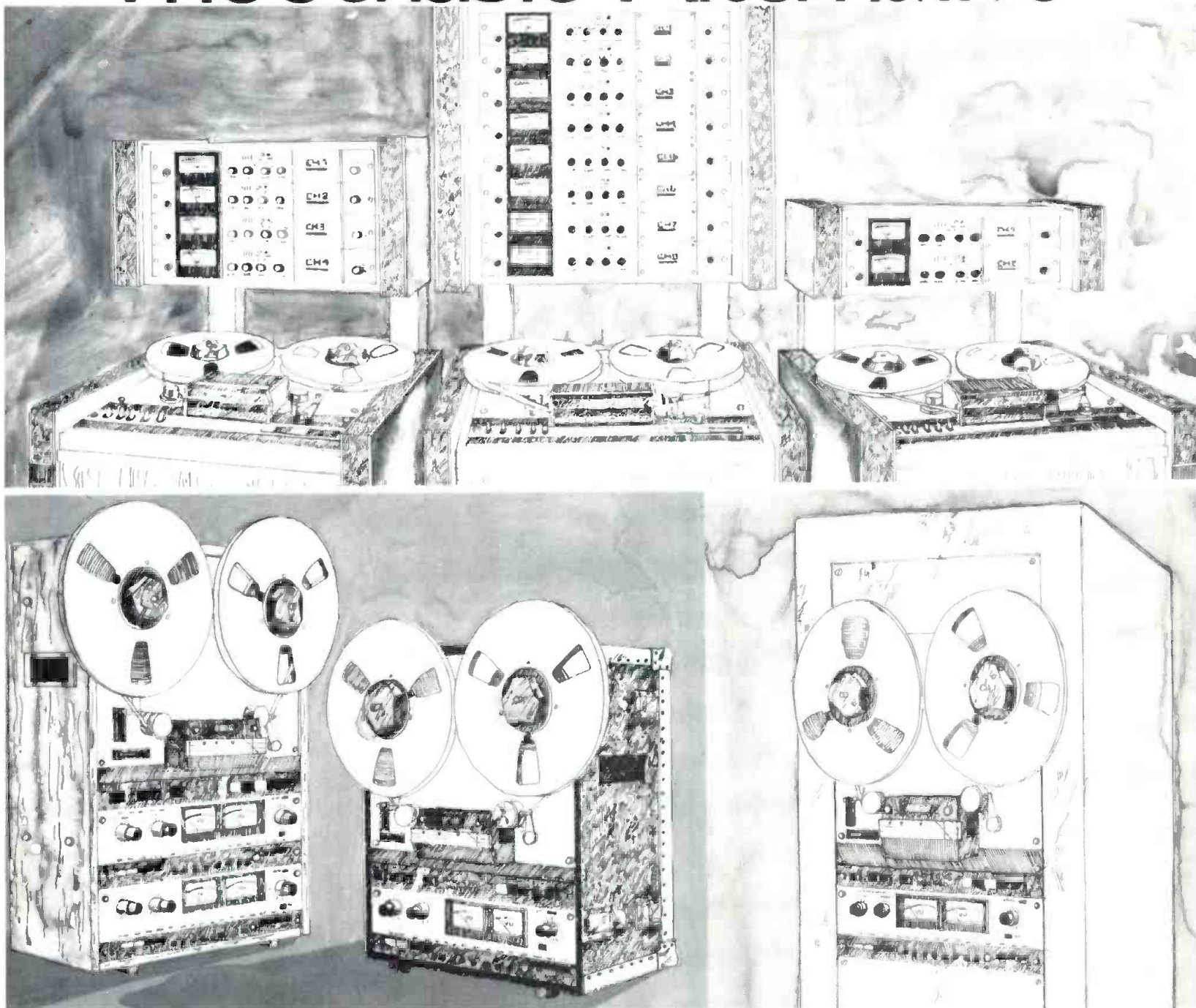

Otari Professional Recorders

Otari's wide line of studio and compact tape machines are the Sensible Alternative in professional recorders. Entirely new for 1975, Otari's MX-7300 and MX-5050 have all the professional features and performance of the more expensive recorders, yet sell at a sensible price. And what's more, Otari recorders are backed by a nationwide parts and service network that you can count on to keep you operating.

Check the features. Check the performance. Then specify Otari, the sensibly priced alternative in professional recorders.

Otari Professional Features — All Models. • Motion sense control logic • Front panel edit and cue • Selective synchronization • DC capstan servo option • 600 ohm + 4 dB output and XL connectors • Built-in test frequencies and standard reference level. **MX-7300 Series Studio Recorder** • Three electrical switchable speeds on one, two, and four channel • Two speeds (7½/15 or 15/30) on eight channel. Eight channel has compatible one-inch format and optional remote synchronous reproduce. **MX-5050 Compact Recorder** • All professional features and performance listed above • Two or four channels • 7½/15 or 3¾/7½ • Cabinet, portable, or rack mount.

OTARI

Otari Corporation
981 Industrial Road San Carlos, CA 94070
(415) 593-1648 TWX: 910-376-4890

In Canada:
Noresco

Circle 16 on Reader Service Card

www.americanradiohistory.com

THE SOUND WORKSHOP 882 RECORDING/PA MIXING CONSOLE



THE FIRST IN A MUCH NEEDED LINE OF PROFESSIONAL AUDIO PRODUCTS

- **the sound workshop 882 recording/pa mixing console** **\$ 1200.**
 8 inputs (line or mic)
 5 output busses (left & right program; monitor; echo; solo)
 each input includes fader, pan pot, echo send, monitor send, mute, solo, high and low frequency eq, trim, line/mic switch, and link jack for direct output or insertion of signal processing device
 120 volt ac or battery operation
 table top or rack mounting
 expandable to 16 or 24 inputs
 all busses meet 'program out' specs
 field serviceable (console consists of 8 input boards, 1 mother board, and 1 power supply board, all removable without a soldering iron!!)
 meter/monitor panel (model 801) available
- **the sound workshop discole mk III phono mixer/pre-amp** **\$ 495.**
 ideal for discotheque, home, or small broadcast studio
 3 stereo cueable inputs (standard configuration; 2 phono, 1 high level)
 mic feeds both output channels
 built in high power stereo headphone amp (2 watts per channel)
 'cue send' output
 reliable rotary faders for 'radio feel' and ease of maintenance
 table top or rack mounting
 plug in circuitry
- **the sound workshop 242 stereo reverberation system** **\$ 375.**
 exclusive MIC FEED LOOP allows direct use with any tape deck with mic/line mixing
 2 independent mono channels, full stereo, or mono send/stereo return
 separate eq for each channel
 led overload indicators for each channel
 3½ inch standard rack mount
 it sounds great, too!!
- **the sound workshop 6741S electronic crossover** **\$ 250.**
 2-way stereo, or 3-way mono
 exclusive OVERLAP CONTROL allows critical level adjustment at crossover frequency
 independent high and low level controls for each channel
 all active circuitry
 3½ inch standard rack mount

sound workshop professional audio products carry a 2 year parts and labor guarantee, and are available from audio by zimet, and a growing number of qualified audio dealers. please write for additional information.

↩ Sound Workshop ↪

PROFESSIONAL AUDIO PRODUCTS

BUILT BY THE PEOPLE WHO USE THEM

exclusive distribution

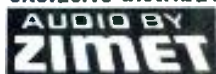

1038 NORTHERN BLVD.,

ROSLYN, N.Y. 11576 (516-621-0138)

Circle 17 on Reader Service Card

The author replies:

His lament lies in his firm belief that I said "three cows squared is nine cows," and he fails completely to recognize that the entire premise of my article is that three cows squared is NOT nine cows. I noticed from his letterhead that Mr. Connally is president of what appears to be an electronics firm, perhaps dealing in computers. How ironic, for it is precisely because the existence of computers has taken much of our arithmetic aptitude away from us that this article was written in the first place.

Marshall King

CORRECTION

In Marshall King's article, "How to Handle a Square," Jan. 1975, there was a typographical error on page 32, second column. In *Calves* section of Problem II, the second line should read: = (3)² (10⁻³)² calves. The rest of the math is correct.

THIS IS A GREAT MIC!... ROGER!

The MP Series is the latest advancement in zone page systems. Available with two thru twelve paging zones.



Quality Engineered Sound Products
 SESCO, INC.
 P. O. Box 590, Gardena, CA 90247 U.S.A.
 (213) 770-3510 • TWX-910-3286189

Circle 19 on Reader Service Card



WORAM AUDIO ASSOCIATES

Consultants in Studio Systems
 Engineering, Design and Installation

—offering—

A COMPLETE CONSULTATION
 SERVICE FOR STUDIO
 PLANNING AND
 CONSTRUCTION

FREE-LANCE RECORDING
 SERVICE IN THE
 NEW YORK AREA

212 673-9110
 64 University Place
 New York, N.Y. 10003

Bellow into it, sweat over it, man-handle it. Practically jam it into the bell of a trumpet. Without overloading. Without distorting.

This AKG D-140E is a super-tough single element, cardioid dynamic microphone that's sensitive enough for top studios or concert halls.

Frequency range: 30 to 15,000 Hz. SPL for 0.5% THD: at 1000 Hz is 129dB. Its front to back discrimination exceeds 18dB at 1000 Hz at a sound incidence angle of 180°.

The D-140E can be boom mounted or hand held. There are no grills or openings on the shaft to cause feedback or alter response when hand held.

The compact size of the D-140E works on stage or TV too.

While it delivers all the high quality audio a program produces, it's so small it can't hide anybody's video.

The D-140E lets music sound life-like, without any coloration of its own. There's a 12dB bass roll-off filter switch recessed into the handle to let you reduce the proximity effect. Or retain it, as the needs of a session dictate.

The D-140E's transducer is internally suspended and encapsulated by a wire mesh/urethane foam windscreen/shield. So handling noise, dust, wind and popping won't interfere with your work.

See your professional equipment dealer for the D-140E or write to us. Before the pressure builds up.

AKG MICROPHONES • HEADPHONES

distributed by:

PHILIPS AUDIO VIDEO SYSTEMS CORP.

AUDIO DIVISION

91 McKee Drive, Mahwah, New Jersey 07430

A North American Philips Company



For the pressure of your company.

(At 129dB, distortion is less than 1%.)



Circle 20 on Reader Service Card

www.americanradiohistory.com

**Now! Monitor
audio channels
visually—
the easy way**



ADM VUE-SCAN

Eliminates
"head-swiveling"—
replaces up to
28 VU meters

You keep your eyes on a single TV-type screen instead of eyeballing a whole string of VU meters. VUE-SCAN displays each analog channel as an easily-read illuminated bar. The bars are always present as a background reference. As the voltage level of a channel increases, the bar representing it increases in height and color intensity. Blue represents a normal operating condition—red immediately signals an overmodulated condition. VUE-SCAN can be used as a self-contained accessory with any Audio Designs or competitive console. Write us for details.



ADM Consoles are built to the most exacting quality standards. Unique plug-in modules provide exceptional flexibility for expansion.

AUDIO DESIGNS AND MANUFACTURING, INC.
16005 Sturgeon, Roseville, Michigan 48066
Phone: (313) 778-8400, Cable: AUDEX
In Canada: TELAK, Scarborough, Ont.
(416) 438-3804

CALENDAR

MAY

- 13-16 London International Electronic Component Show. London.
- 13-16 Audio Engineering Society, 51st Convention, Los Angeles Hilton. Los Angeles, Ca.

JUNE

- 9-27 Brigham Young University Audio Recording Technology Course. Contact: Russel Peterson. Brigham Young University, Audio Recording Technology Course, 242 Herald R. Clark Building, Provo, Utah 84602. Phone: (801) 374-1211, ext. 3784.
- 15-18 AMTEC '75, Canadian Educational Communications Conference of the Association for Media and Technology in Education, Calgary, Alberta, Canada. Contact: Garry Smith, ACCESS Television South, Calgary Health Sciences Centre, 1611 29th St. N.W., Calgary, Alberta T2N 4J8.

JULY

- 8-11 INTER NAVEX '75 (Audio Visual Aids in Education) London.

SEPTEMBER

- 28-Oct. 3 SMPTE Technical Conference and Equipment Exhibit. Century Plaza Hotel, Los Angeles. Contact: SMPTE Conference, 862 Scarsdale Ave., Scarsdale, N.Y. 10583.
- 29-30 N.Y. Chapter of ERA, Commercial Sound & Communications Show, Statler-Hilton Hotel, New York City. Contact: GIM Sales Corp., 375 N. Broadway, Jericho, N.Y. 11753 (516) 433-4080.

In response to numerous requests, we are compiling a list of schools with audio departments. If your school would like to be listed, include the following information: degree granted, if any, length of course, tuition rate and of course the address to which the prospective student can write for more specific information. Send your listing to Hazel Krantz, db Magazine, 1120 Old Country Rd., Plainview, N.Y. 11803.

RADFORD

Audio Measuring Instruments

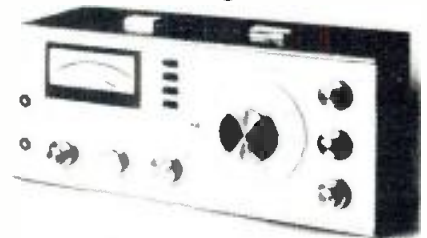

Low Distortion Oscillator Series 3

A continuously variable frequency laboratory oscillator with a range of 10Hz-100kHz, having virtually zero distortion over the audio frequency band with a fast settling time.

SPECIFICATIONS:

Frequency range: 10Hz-100kHz (4 bands)
Output voltage: 10 volts r.m.s. max.
Output source resistance: 150 ohms unbalanced (plus 150/600 balanced/floating)
Output attenuation: 0-100dB (eight, 10dB steps plus 0-20dB variable)
Output attenuation accuracy: 1%
Sine wave distortion; Less than 0.002% 10Hz-10kHz (typically below noise of measuring instrument)
Square wave rise and fall time: 40/60 n.secs.
Monitor output meter: Scaled 0-3, 0-10 and dBV.
Mains input: 110V/130V, 220V/240V
Size: 17" (43cm) x 7" (18cm) high x 8 3/4" (22cm) deep
Price: 150 ohms unbalanced output: \$950.00.
150/600 unbalanced/balanced floating output: \$1070.00.

Distortion Measuring Set Series 3

A sensitive instrument with high input impedance for the measurement of total harmonic distortion. Designed for speedy and accurate use. Capable of measuring distortion products down to 0.001%. Direct reading from calibrated meter scale.

SPECIFICATIONS:

Frequency range: 5Hz-50kHz (4 bands)
Distortion range (f.s.d.): 0.01%-100% (9 ranges)
Input voltage measurement range: 50mv-60V (3 ranges)
Input resistance: 47Kohms on all ranges
High pass filter: 12dB/octave below 500Hz
Power requirement: 2 x PP9, included
Size: 17" (43cm) x 7" (18cm) high x 8 3/4" (22cm) deep
Price: \$770.00

AUDIONICS

10035 NE Sandy Blvd.
Portland, Oregon 97220
Authorized U.S. Sales Agency for
Radford Laboratory Instruments

SUNN ELECTRIFIES 'CIRCUS MAXIMUS'

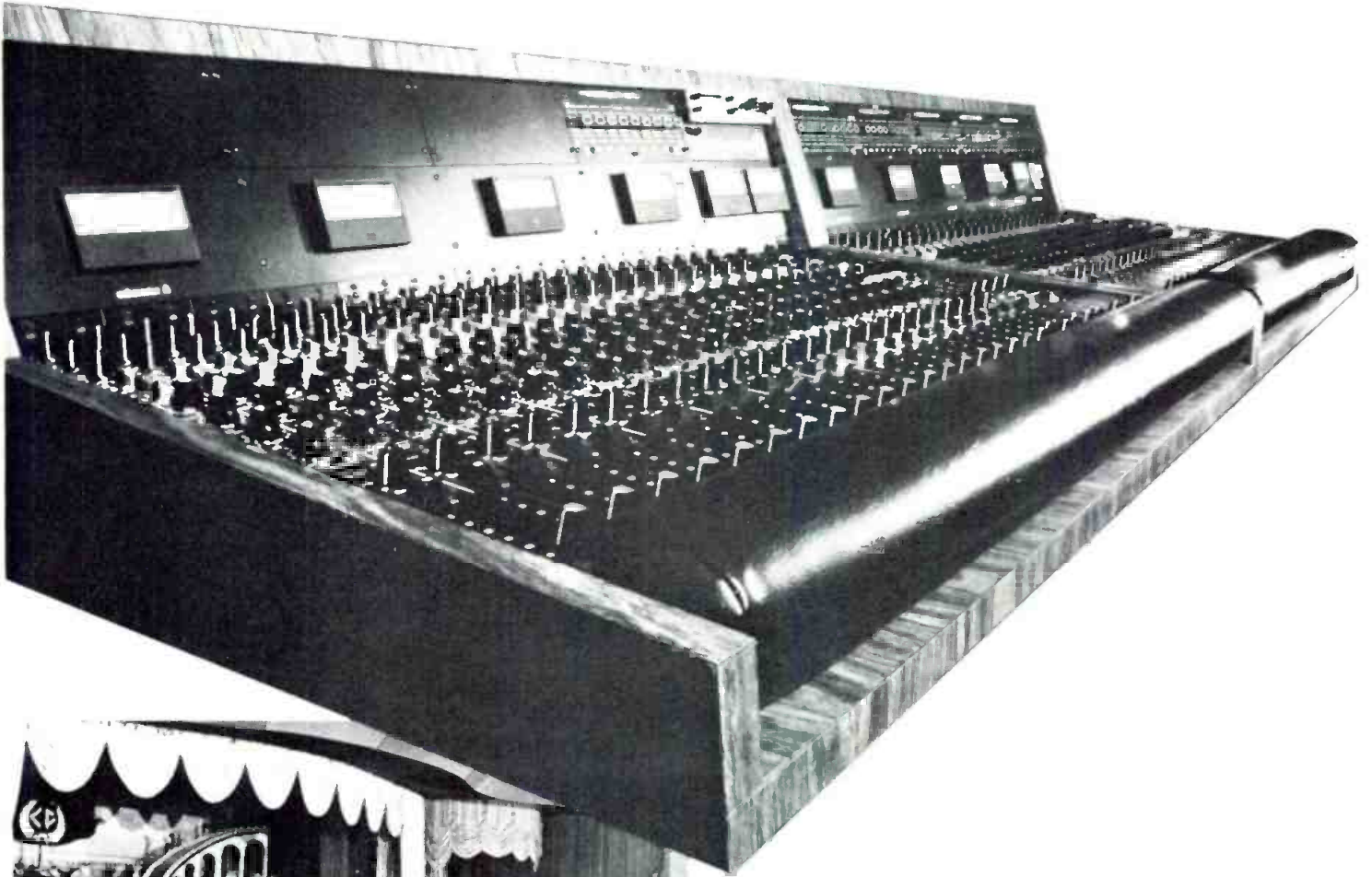

sunn MAGNA 5000!

At SUNN, we've been making professional sound reinforcement products for years. Our lab has been the concert stage.

After an extended evaluation of the specifications, utility, and versatility of our MAGNA 5000 control console, Caesar's Palace in Las Vegas installed it as part of the new sound system in the Circus Maximus showroom.

Modular in design, easily interfaced with all state-of-the-art electronic components, the MAGNA 5000 was the obvious choice of Caesars management to meet the exacting demands of the regular bill of superstar performers that appear there.

We invite you to check further into the MAGNA 5000 console. Write us here in Oregon or check out your local dealer or contractor.

sunn  MAGNA

Amburn Industrial Park • Tualatin, Oregon 97062

Circle 23 on Reader Service Card

www.americanradiohistory.com

STEVENSON
INTERFACE

Designed primarily for recording studios, Interface Electronics mixers are also now increasingly being used in sound systems, and especially portable sound systems because of their flexibility, ruggedness, reliability and portability. Track masters are used as submasters (up to eight with the Series 300) and the mixdowns provide for feeding each submaster to right or left or any shading between, with mixdown masters used for right and left sound system masters.

Now in fully wired mainframes with input and output connectors and integral lighted four inch VU meters, the Models 16X8, 24X8 and 30X8 can be supplied with Talk-Slate module for recording studio use or in foam-lined trunk for portable use. Price of the complete 24X8 is \$10,340.00.

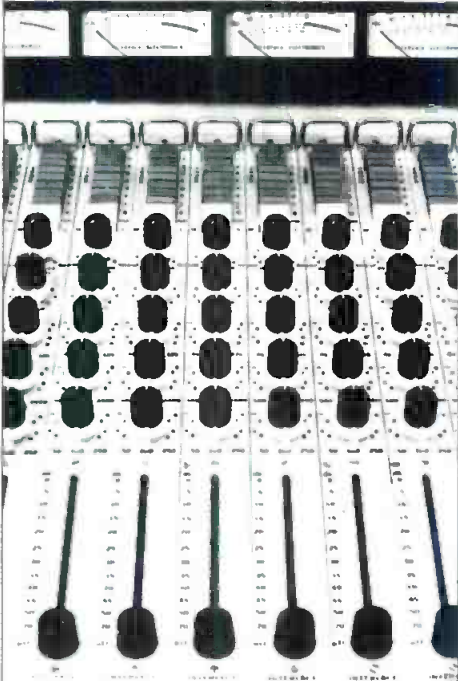

CATALOG SUMMARY

Series 100 four track mixers available in 8X4, 16X4, and 24X4, with a variety of module options

- 100B - three equalizers, switched frequencies
- 100C - compressor, 40 db
- 100D - standard two equalizer
- 100J - eight output stage monitor
- 100L - eight output matrix stage monitor
- 100Q - joystick quad
- 100R - sound system and stage monitor

Series 200 two track mixers available in Model 8X2 and (on special order) 16X2, with stereo or two independent outputs.

Series 300 eight track mixers available in Models 16X8, 24X8, and 30X8, with two input module options

- 308A - seven equalizers
- 308B - three equalizers, switched frequencies.

Special Options: internal reverb on one track (Series 100 and 300), +8 dbm balanced transformer outputs.

Fully modular and plug-in: order mainframe and only those modules needed, add more later if required.

INTERFACE ELECTRONICS
3810 WESTHEIMER • HOUSTON, TEXAS 77027 • (713) 626-1190

- California: Custom Fidelity, Hollywood, David Berkus, 213-654-4522; Lumiere Productions, San Francisco, Bob Walker, 415-989-1130
- Illinois: Milam Audio, South Pekin, Jerry Milam, 309-348-3112; Gill Custom House, Chicago, John Gill, 312-598-2400
- Iowa: Advanced Audio, Iowa City, Mark Mathler, 319-354-3104
- Massachusetts: Terry Hanley Audio, Cambridge, Terry Hanley, 617-661-1520
- Michigan: Systems & Technology, Kalamazoo, Greg Hockman, 616-382-6300
- New York: Harvey Radio Company, New York, Don Plunkett, 212-832-8675; Boynton Studio, Morris, James Boynton, 607-236-5695; Unistage, Buffalo, David Zierk, 716-853-6500
- Ohio: Sunset Sound, Columbus, Richard Shoemaker, 614-239-6945
- Pennsylvania: Short Sound Systems, Pittsburgh, Dave Short, 412-781-2326
- Tennessee: Carlo Sound, Nashville, Rich Carpenter, 615-356-0202
- Texas: Interface Electronics, Houston, Louis Stevenson, 713-626-1190; United Audio, San Antonio, Phil Blakeley, 512-684-4000
- Canada: Neresco Manufacturing Co., Toronto, Bob Cook, 416-249-7316

● My correspondence during the last month has illustrated a principle that is important to everything an audio man does, possibly to everything that anyone does. It is something that I have stressed in my mediated course on English but it is important in a great many contexts today.

Since I started writing this column, several years ago now, a few people have taken issue with what I have written. Once in a while, as I commented in the March issue, I do make a mistake. More often, the difference occurs because the reader finds what I say at variance with what he already believes. And this is a basic situation in which the principle I want to talk about applies.

So I'm writing, very often on the basis of building on what I have said before, assuming that readers have accepted, or at least read, what I wrote then. One reader brought this home to me by commenting that he is now convinced that I have an adequate knowledge of psycho-acoustics. Prior to that he had not been convinced, because what I wrote seemed to differ from what he already believed.

What is necessary, and the important thing to which I refer here, is the need to come at the question from the viewpoint of the person you are addressing. Assertions convince nobody. A person already convinced of the point asserted, will nod and say, "True!" But a person unconvinced already will not believe a thing on someone's say-so, unless the credibility of the someone is already established.

In today's school context, a slight variation of this occurs, that has influenced the attitude of people quite considerably, not for the better. Students are also unready to believe something for which adequate basis is not provided. In today's school system, few teachers provide adequate basis for anything they teach.

The result of this anomaly is that the majority of students, who grow up to be the majority of adults, really believe very little of what they hear. In school, they know that those all-important grades depend on giving the answers that teacher expects. Because they cannot believe all that teacher says, they form the habit of giving answers expected, without bothering their heads about whether they are true or not.

So we find that more and more

people in today's world will answer you in the way you expect them to. They have mastered that lesson in school quite well. They listen to the way you talk. If you talk as if you believe in God, for instance, they will respond as if they do. If you talk as you think belief in God is a relic of the "dark ages," that is how they will respond. The awful thing is that many of these people are devoid of personal belief.

MATHEMATICS EDUCATION

An experience I have related before, about the observation of various math classes in our own local school district, through grades 7 to 12, has an aspect related to this. One group I addressed was the 9th grade general math. After less than ten minutes talking to this group, they really turned on. Their attitude was evident to get to make sense of this stuff!" And afterward they gathered round me, "Are you going to teach this regularly?" Unfortunately the teachers couldn't wait to make sure I didn't get to do that!

On the other side of the coin was the math analysis class, which is college level math, taken by juniors and seniors who rate as "straight A" students. Here too, I quickly got the impression that, although they were differentiating and integrating, and all those things, they didn't know why they were doing it the way they had been shown, or really, just what it was they were doing.

So I asked them. The response I got implied that they were impatient with me. If I didn't know such advanced math, why would I come and observe their class, and waste their time? The credibility thing again. I had a quick remedy for that. A few deft tricks, demonstrated on the board, showed I knew more about this "advanced math" than they did.

But still they didn't know what I was asking them. If I would tell them what I wanted them to answer, they would answer it, but please don't expect them to use their brains! In the 9th grade general math group, the whole class had turned on in minutes. In later weeks, two members of that math analysis class came to me for help, realizing that what I had been trying to get across was very important indeed: the need to know what you are doing! (continued)

It makes audio communications measurements too...

Tektronix TM 500



- digital multimeters
- counters
- generators
- amplifiers
- power supplies
- oscilloscopes
- a blank plug-in for your own circuitry
- and more

The TEKTRONIX modular Audio Frequency Instrumentation group provides the test and measurement instruments you most frequently need . . . for only \$1865*. These compact light weight instruments work together as a system or independently within a TM 504 power module/mainframe.

The above TM 500 configuration features a dB reading DM 502 Digital Multimeter with 3½ digit display and optional (\$110)*temperature measurement capability (a function that has proven valuable in identifying active solid-state device circuit problems); the SG 502 Audio Oscillator provides 5 Hz to 500 kHz sine and square waves, 600Ω output, and low distortion (0.035% from 20 Hz to 50 kHz); the DC 504 Digital Counter offers 5-digit LED display of frequency to 80 MHz and period resolution to 1 μs; and the SC 501 Oscillo-

scope is a single-channel, dc-to-5 MHz modular instrument with triggered sweep and vertical sensitivity to 10 mV/division.

All TM 500 plug-ins are readily interchangeable within the entire TM 500 line. Plus there's a blank plug-in kit, which allows you to add your own special circuits to a TM 500 system. The plug-ins can work together synergistically through the common interface circuit board of the power module/mainframes. So you can tailor a system of instrumentation exactly to your needs . . . a system that's only 6" x 11" x 20" and weighs less than 30 lbs. . . . and a system that offers you benefits difficult to duplicate with "monolithic" instruments.

TM 500 is a growing, compatible family of 29 plug-in modular instruments, accessories, and one, three, four, and six-compartment power module/mainframes. Package configurations can be selected for work in high-speed logic circuitry, medical instrumentation, instrumentation calibration, industrial equipment, and more. All may be hand carried, all go on the bench, and there are rack-mounting and SCOPE-MOBILE® configurations as well. You can select from general-purpose instruments, such as the DM 501 Digital Multimeter, or highly specialized instruments, such as the AF 501 Tunable Bandpass Filter or AM 502 high-gain amplifier with calibrated gain to 100 dB and switch-selectable high and low-pass filters. If your work requires the measurement of electrical phenomena in the audio frequency range, Tektronix TM 500 offers substantial benefits to you.

Find out what TM 500 can do for you. Get the TM 500 Catalog A-3072 with full specifications and applications information. Or contact your local Tektronix Field Engineer for a demonstration of how TM 500 offers a better solution to your needs. Write to Tektronix, Inc., P.O. Box 500, Beaverton, Oregon 97077. In Europe, write Tektronix, Ltd., P.O. Box 36, St. Peter Port, Guernsey, Channel Islands.



TEKTRONIX®
committed to technical excellence



* U.S. Sales Prices FOB Beaverton, Oregon

Circle 25 on Reader Service Card

theory & practice (cont.)

THE DIPLOMA INVERSION

This is the inversion I have mentioned before, whereby the people who get the diplomas, degrees and what not are the ones who do so without knowing why, while the ones with real potential (not that the others may not have it too, but it's stifled in a different way) are those who are made dropouts eventually.

Because many teachers are uninspired, slaves to books instead stimulating the desire to probe for meaning, we need to find other ways of putting life in the educational process. One of these ways is through the use of mediated instruction. And yet, one must be careful there, too. Too much mediated instruction rests on the same kind of parrot-authority as poor teaching.

Media can be designed in much the same way I used to turn on the 9th grade general math class. You have to connect with the student's own personal experience so he begins to realize that he is applying his own personal observations to discovery and is not accepting what you put into the media on someone else's sayso.

In connecting with the student's personal experience, you must excite his

curiosity to ask why—the urge that comes naturally to two-year-olds and is progressively quenched in school. You must stimulate him to think about what he already knows, not because he has been told so, but because he has found out for himself.

FROM EDUCATION TO SOUND

You may say, "Oh, that applies to educational material, but not to material intended primarily for entertainment, such as music." No? Look around at the professionals you know who are successful, whether as musicians, or as audio men. What makes them successful?

You will find the same common denominator at work there, too. They are looking for that certain sound: the sound they themselves believe in, what to achieve. Every one of them does this. It may differ from the sound that every other member of their profession believes in, but it is something that is very real to them. Only because of this, can they make it real to others. So the same principle does apply here too.

IN AN ENGINEERING CONTEXT

Perhaps we are really back where we began now, in the context of this column. Have you heard arguments between engineers? Some of the ques-

tions we have treated, from time to time, in this column, perhaps. A person naturally presents a subject in the way it first made its impression on him. That does not say that the impression could not be fallacious. So you often have a situation where two people are arguing, at cross purposes.

Each presents his own view of what he believes to be facts, and avoids the approach to what could be the same set of facts adopted by his opponent. He is convinced that his approach is correct. So he doesn't need to consider his opponent's approach! If he is to convince his opponent, he must. That is his only hope of really winning the argument: to spot the fallacy in his opponent's approach. He must approach the subject the same way his opponent does, but spot where he goes wrong.

The trouble with that is, his opponent may not be the one who is going wrong! For many people, that is a discomfiting thought. But really, very worthwhile.

Often, examining both approaches more critically, to find the fallacy in each, will result in a realization that neither was completely right, and thus yield a better comprehension of the whole subject matter. Better to build on a point of agreement than a point of disagreement. ■

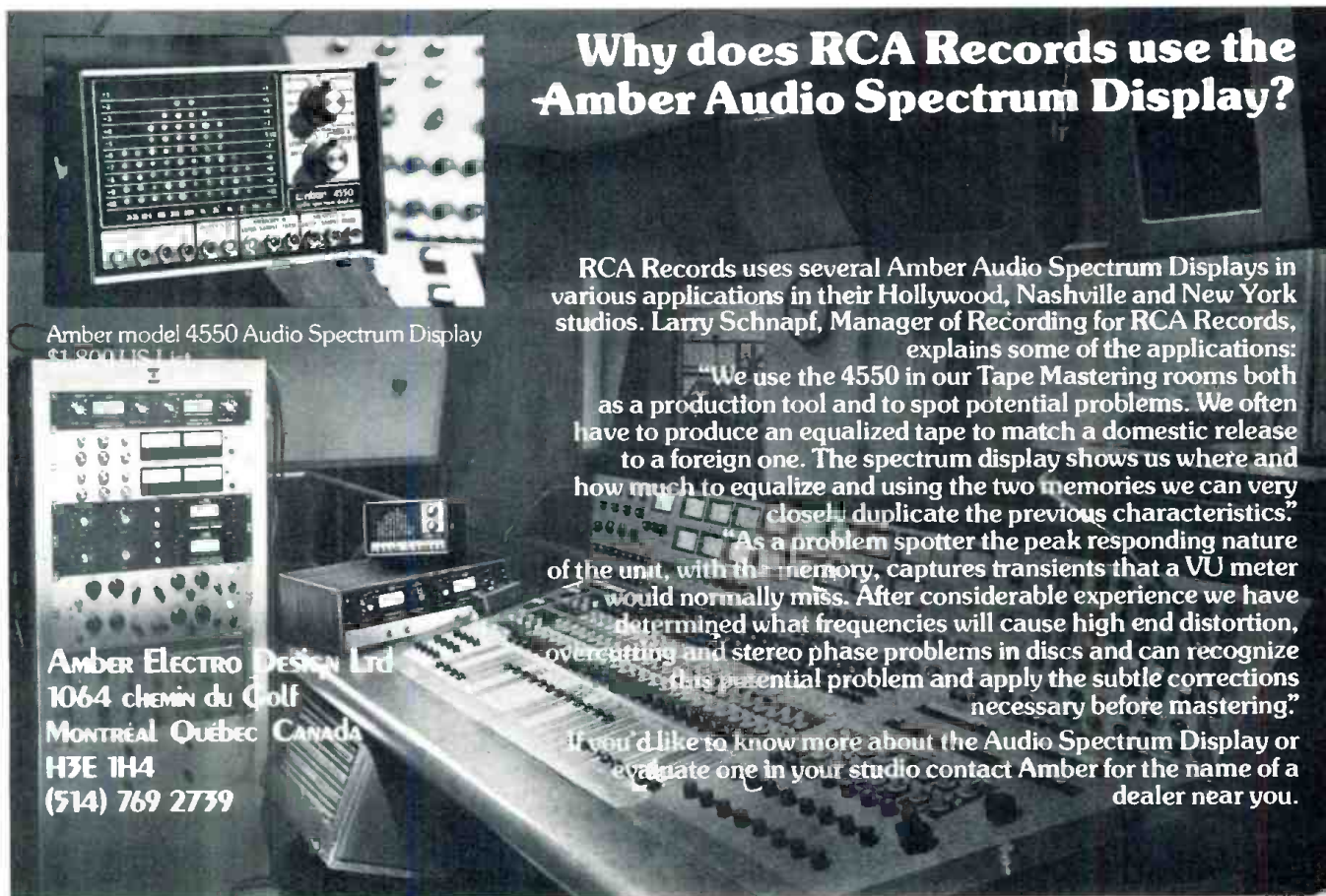

Why does RCA Records use the Amber Audio Spectrum Display?

RCA Records uses several Amber Audio Spectrum Displays in various applications in their Hollywood, Nashville and New York studios. Larry Schnapf, Manager of Recording for RCA Records, explains some of the applications:

"We use the 4550 in our Tape Mastering rooms both as a production tool and to spot potential problems. We often have to produce an equalized tape to match a domestic release to a foreign one. The spectrum display shows us where and how much to equalize and using the two memories we can very closely duplicate the previous characteristics."

"As a problem spotter the peak responding nature of the unit, with the memory, captures transients that a VU meter would normally miss. After considerable experience we have determined what frequencies will cause high end distortion, overcutting and stereo phase problems in discs and can recognize this potential problem and apply the subtle corrections necessary before mastering."

If you'd like to know more about the Audio Spectrum Display or evaluate one in your studio contact Amber for the name of a dealer near you.

Amber model 4550 Audio Spectrum Display
\$1,800 US List

AMBER ELECTRO DESIGN LTD
1064 Chemin du Golf
MONTREAL QUEBEC CANADA
H3E 1H4
(514) 769 2739

db May 1975

12

Circle 26 on Reader Service Card

A call to one of these guys will tell you more about 3M pro audio gear than all the ads we've ever run.

3M PRO AUDIO DEALERS

RECORDING STUDIOS

Ron Newdell
Accurate Sound Corp.
114 5th Avenue
Redwood City, CA 94063
Tel. (415) 365-2843

Welton Jetton
Auditronics Systems
Division
207 Summit Street
Memphis, TN 38124
Tel. (901) 272-9641

Bill Wilson
LaSalle Audio
740 N. Rush
Chicago, IL 60611
Tel. (312) 266-7500

Bruce Martin
Martin Audio/Video
320 West 46th Street
New York, NY 10036
Tel. (212) 541-5900

Rick Maze
The Maze Corporation
514 Alton Road
Birmingham, AL 35210
Tel. (205) 591-4800

Jerry Milam
Milam Audio Corporation
700 West Main Street
South Pekin, IL 61564
Tel. (309) 348-3112

Tom Hidley
Westlake Audio
6311 Wilshire Blvd.
Los Angeles, CA 90048
Tel. (213) 655-0303

GSA CONTRACTS

Lee Deane
Fidelity Sound Co., Inc.
1200 18th St., N.W.
Washington, D.C. 20036
Tel. (202) 296-9110

TELEVISION APPLICATIONS

Byron Fincher
RCA Broadcast Systems
Camden, NJ 08102
Tel. (609) 963-8000

If you know the recording industry, you know at least one of the men on the sheet above. And you know you can count on getting straight answers from them.

So if you want to know where 3M is really at in this business, these guys can tell you.

The fact is, 3M audio equipment has worldwide acceptance, and we back it up with a superb organization, our Business Products Service, with offices in New York City, Memphis, Washington, D.C., Detroit,

Chicago, San Francisco, Los Angeles, Atlanta, Pittsburgh, Providence and Grand Prairie, Texas.

And we have a special flying squad of troubleshooters that we can dispatch from our St. Paul headquarters on a moment's notice for big problems. So when it comes to service, 3M leads the industry. Something you might want to keep in mind when some other companies have been cutting back on their service capabilities.

And we think it's great when the guys in the sales organizations around the country praise 3M equipment.

Because we think word-of-mouth advertising is the best kind there is.

Our ad agency hates it, though.

It's not commissionable.

PROFESSIONAL AUDIO PRODUCTS
Mincom Division **3M** COMPANY
3M CENTER • SAINT PAUL, MINNESOTA 55101

Circle 27 on Reader Service Card

www.americanradiohistory.com

THESE AMPS SOUND BEST!



MODEL 250



MODEL 500D



MODEL 750A

BECAUSE THEY HAVE:

- No current limiting circuits to produce buzzes, rattles, or chirps at high levels.
- Enough muscle to create the effects for Universal Studios' great new movie sensation EARTHQUAKE.
- Incredibly accurate high speed OpAmp circuitry to eliminate phase shift and crossover distortion.
- Specs which meet the stringent, new FTC Regulation on Amplifier Ratings, while practically all others don't!

For data sheets and a reprint of the article "FTC Power Ratings: An Optimistic View," (Audio Magazine, Feb. 1975) write or call:



in Canada... Recrion, Limited
23 Vesta Drive
Toronto, Ontario
M5P 2Z6

BGW Systems
P.O. Box 3742
Beverly Hills
CA 90212
(213) 391-0320

• Beginning in June of last year and continuing through several subsequent columns, we discussed an interlock unit, published a letter or two on other models of the same type, talked about how to care for a projector, and printed a letter on that subject, too. Since then, several other interesting pieces of information on these subjects have come to us and we should like to share them with you. First a letter, written in September of '74 but held until we got the chance to go back to the topic. Then, some new things which should be of interest.

"I have recently been reading your *Sound With Images* column in *db*. I thought you and your readers might be interested in some of my experiences with our Sonorex 16-16 projector. We have been using this projector for over two years now and are quite happy with it. For the price, it is one of the most versatile devices I have seen. We have, however, experienced several technical problems with our machines which other readers might encounter. Our major problem has been the unavailability of adequate service information for this projector. In most cases, when we have had technical problems, we have been forced to telephone the Arriflex Service Dept. in New York. The people there have been very helpful to us in correcting malfunctions. When needed, they have sent us replacement parts, often at no cost.

"Some of the specific problems we have had include failure of the built-in monitor speaker the first time the projector was used, difficulty with the projection lamp failing to light, a sheared pin on a shaft in the drive system preventing film motion and a broken bracket which holds one of the idler rollers on. The service department in New York sent out a new speaker with the explanation that the old one was rated inadequately and therefore the problem often occurred. The speaker they sent, however, would not fit inside the projector case and we never were able to install it.

"The problem with the projection lamp was traced to a centrifugal switch on the flywheel which prevents the lamp from operating before the projector gets up to speed. Contact cleaning solved this problem. However, the sheared pin proved to be more difficult. The projector had to be considerably dismantled and the old pin drilled out before a new one could be installed. The bracket for the idler is the one on the picture film

side of the projector which operates the end-of-film cut off switch. After consulting with people at Arriflex, we decided to repair the bracket with some high quality epoxy glue. This solution has continued to hold up adequately now for several months and I do not expect any further problems from it.

"I have been enjoying your column and I hope this information will be of some benefit."

Sincere thanks to Charles B. Kenamer, Coordinator, Radio and Television Services, South Oklahoma City Junior College, Oklahoma City. We welcome comments from other readers who have had any experience with any audio/visual equipment. We should like to share it with others.

PROJECTOR LAMPS

On the subject of taking care of projectors and their lamps, we raised the question of whether it was better to run the projector's fan (without the lamp) to cool the unit and extend the life of the lamp. In checking on this question before writing on the subject, we found that the 16mm projector operating instructions by Kodak did not have any remarks about this, but their slide projector users were told, in the operating instructions for the Carousel 850, for instance:

"After showing your slides, the projector will be warm. Slide the power switch to FAN and allow the fan to run for several minutes until the projector feels cool; then slide the switch to OFF."

In checking instructions for similar carousels of later make than the model 850, we noticed the above note was deleted. This led to the investigation of other pieces of informative literature. We found a Kodak AV Equipment Memo #S-53 entitled *Heavy-Duty Operation of Kodak Ektagraphic and Carousel Slide Projectors*. Under the heading LAMP LIFE a portion of the paragraph reads:

"If you can accept a reduction in light output, the lamp life can be extended considerably by operating the lamp at reduced voltage. With a properly operating projector and adequate ventilation, 120-volt lamp-life can be increased about two times at 115 volts and about three times at 110 volts. If your projector has a LOW-HIGH setting, life expectancy can be quadrupled at the LOW setting.

"The fan should normally not be operated after the projector lamp has been turned off, because the rapid

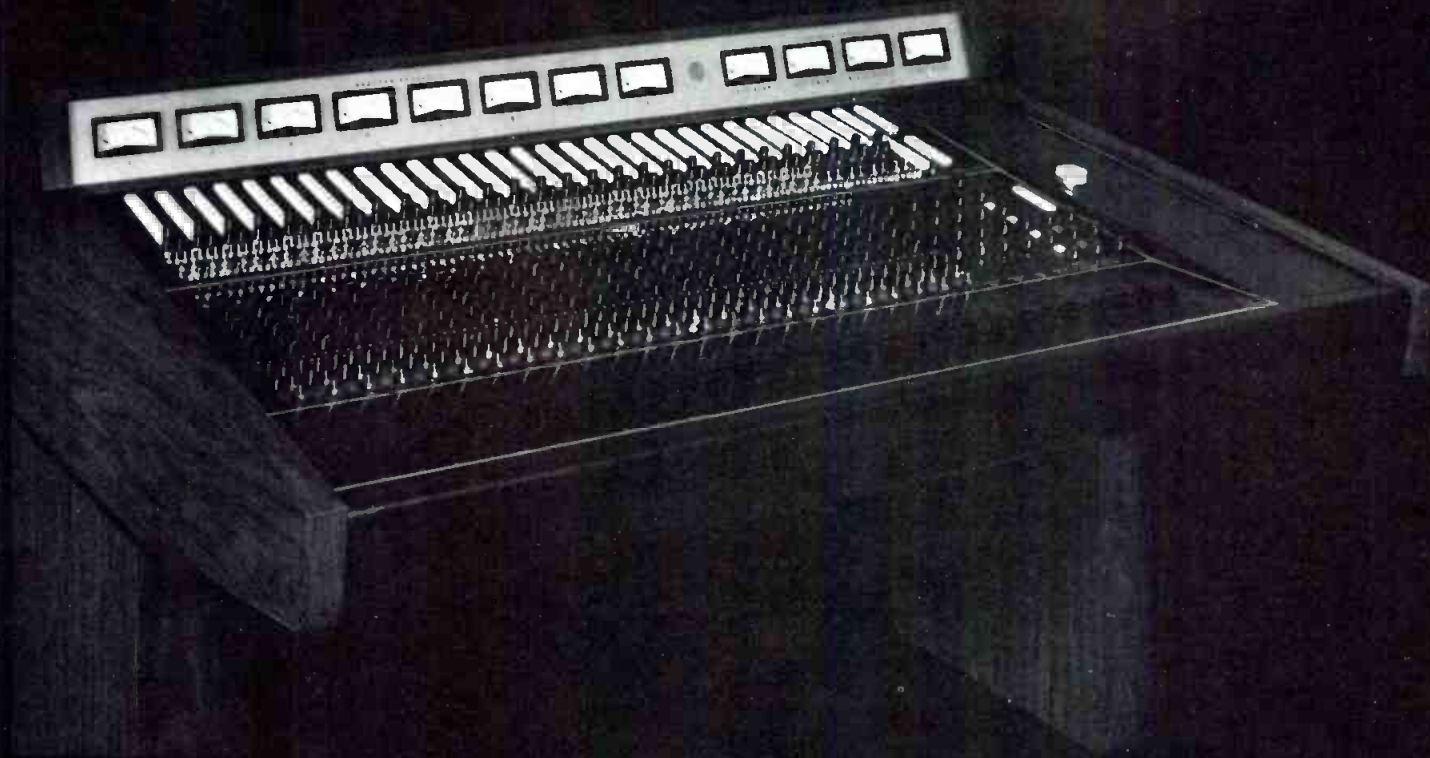

QUALITY: SPECTRA SONICS audio control consoles show the care and attention to detail that are the mark of the skilled American craftsman. The internal wiring, module construction, console housing and the control display reflect the precision and distinctive craftsmanship that is characteristic of SPECTRA SONICS.

CAPABILITY: SPECTRA SONICS audio control consoles provide an immediate initial capability that may be increased to 24 inputs and 24 outputs, at minimum cost. The flexibility of the system will provide line/microphone selection, attenuation, equalization and, through assignment controls, various other combinations for the most sophisticated signal processing now required in today's studio.

RELIABILITY: SPECTRA SONICS audio control consoles have an established reputation of superior reliability. Through creative design, the circuitry is developed to function well below operating limits to enhance an extended life for the components. Through empirical data on SPECTRA SONICS audio amplifiers, a reliability rate of 99.9% has been derived. These amplifiers are used in SPECTRA SONICS audio control consoles and materially contribute to system reliability.

PERFORMANCE: SPECTRA SONICS audio control consoles are guaranteed to outperform any other console in the world in noise, frequency response, distortion, and peak overload. All consoles are provided with documented data acquired in tests of the complete system. Guaranteed performance specifications are: Frequency Response, $\pm 1/4$ dB 20Hz-20kHz; Signal/Noise Ratio (microphone input), not less than 82.5dB below +4dBm, output for a -50 input (50 ohms source); Signal/Noise Ratio (line input), not less than 87dB below +4dBm output for a +4dBm input; Harmonic Distortion, less than .01% at +18dBm (1kHz); Intermodulation Distortion, less than .02% at +4dBm; Crosstalk, not less than 60dB at 20kHz (typically 80dB).

Call or write for details on SPECTRA SONICS Model 1024-24:

770 Wall Avenue
Ogden, Utah 84404
(801) 392-7531

6430 Sunset Blvd., Suite 1117
Hollywood, California 90028
(213) 461-4321

SPECTRA SONICS

LEADER IN ADVANCED TECHNOLOGY



sound with images (cont.)

flow of relatively cool air tends to set up stresses in the lamp, condensers, and the heat-absorbing glass by cooling their surfaces rapidly. The fan may be operated for a short time to accelerate cooling of the projector for comfortable handling or to change the lamp in the event of a burnout."

Note the part about not operating the projector in order to cool the unit and the lamp after the lamp has been turned off. That was interesting, so we called Kodak and spoke with a top engineer at the company. He informed us that there would not be any further mention in operating instructions for carousels that the projector should be run without the lamp after the showing. The reason was as indicated in S-53, that stresses were set up in the various glass parts. However, the part that was most susceptible to damage with the fast cooling process was the heat-absorbing glass that was located between the two lenses inside the projector. He also said that this particular piece of glass has also undergone a manufacturing change in order to reduce the possibility of its breaking.

It seems that the circular heat-absorbing glass had been made with

sharp edges on the flat sides. When the glass cooled fast, the sharp edge of the thick glass was where the fracture began. This edge also was prone to chipping, with the same breaking result. The newer pieces of heat-absorbing glass are made with beveled edges to prevent, or at least reduce, the possibility of breaking. He also made a recommendation regarding the cleaning of the glass and suggested we refer again to S-53. Right there, under PROJECTOR MAINTENANCE, was the instruction he recommended.

CARE OF GLASS

"CAUTION: After a few hundred hours of operation, the heat-absorbing glass becomes more susceptible to breakage by handling or thermal shock. Therefore, it is best to clean it in place without rotating it or removing it from the projector."

While we're on the subject of heat dissipation, one suggestion is always made regarding keeping projectors cool. An air-conditioned atmosphere is recommended, although normal air temperature will do. Another suggestion is to have a blower exhaust in the room where the projection equipment is located. Sometimes projection room designers ask a/v specialists or sound system installers how much heat the

equipment in the projection or control room will give off. Most of the time, the information given has to do with the watts of power the equipment will use. The designer then calculates the heat that has to be carried off.

The key to the calculation is the conversion from watts to BTUs. The BTU number is what air conditioning specialists need. The wattage is what you have discovered either by looking on the nameplate or by multiplying the current by the voltage. Then, if you remember that every watt generates about 3.4 BTUs, multiplying the power consumption of all the equipment in the projection booth by this 3.4 figure gives the BTUs that have to be dissipated. You can also remember 3400 BTUs for every kilowatt; it's the same thing. Incidentally, the BTUs you compute are created every hour. This now tells the air conditioning man how much heat he has to get out, at least from your equipment. This might not include lights, or other accessory units unless you were smart enough to include them.

The next time we discuss 16mm projectors, we hope to include some more letters from our readers, or some new equipment that is accessory to the projector itself, or even how the lenses work. We welcome any and all comments on this or any subject. ■



Complete Audio Distortion and Frequency Response ... Automatically

RADIOMETER COPENHAGEN

Comprehensive distortion and frequency response measurements are easily performed with the BKF10 Automatic Distortion Analyzer. This unique instrument combines a distortion meter, a low distortion audio sweep oscillator (<0.01% t.h.d.) and an input/output ratio meter. Operation is totally automatic . . . No balancing, nulling or level setting is required. Addition of a recorder provides complete distortion and frequency response curves. Send for complete information.

THE LONDON COMPANY / 811 SHARON DRIVE / CLEVELAND, OHIO 44145 / (216) 871-8900

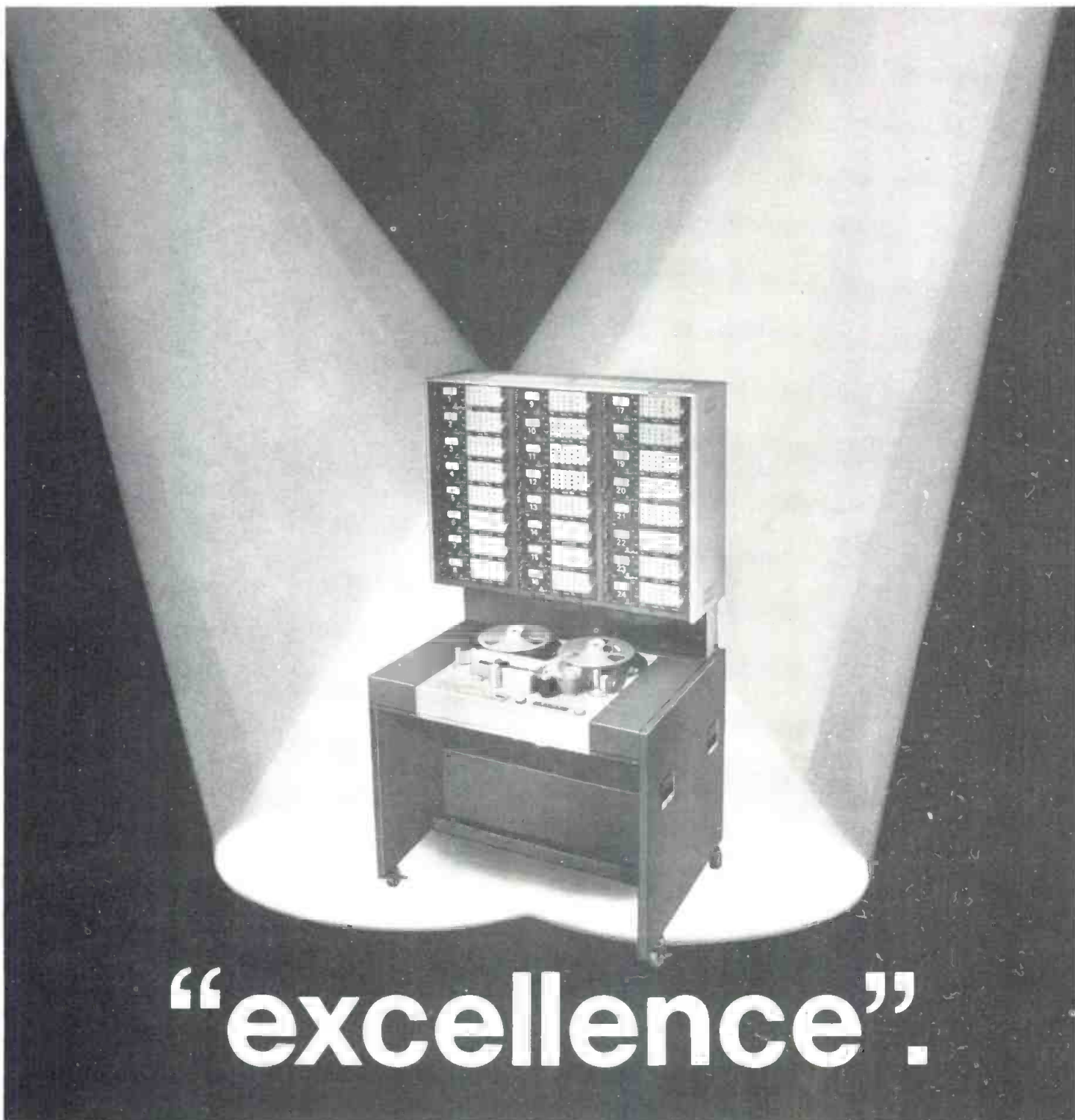

“excellence”.

For over twenty-five years the *Studer* name has stood for excellence. Through the years Studer tape recorders have come to be recognized throughout the world as a standard of the broadcasting and recording industries. Studer's A80/VU Recorder was developed for use in recording systems where only the highest quality is acceptable. The great care taken in the design, development and construction of the A80/VU is reflected in its unusual reliability and stability. A superior transport combined with a

versatile electronics system and high-precision heads allow studio personnel to work surely. With the recorder a stable, predictable instrument, the energies of the mixer and producer can be applied totally to the creative aspects of their work. For complete information contact . . . WILLI STUDER AMERICA, INC., 3916 Broadway, Buffalo, New York 14227—phone 716 681-5450. (In Canada: WILLI STUDER CANADA, LTD., 416 423-2831)

WILLI
STUDER
AMERICA

Circle 31 on Reader Service Card

www.americanradiohistory.com

Audio Booms in Discotheques

Discotheques are vibrating again in major cities here and abroad. What's the sound like? Will it spread?

THE DISCOTHEQUE scene is upon us again, if you haven't noticed it already. L.A.'s Rodney's, New Orleans' Place Across the Street, Washington's Pier 9, Chicago's Bistro, and New York's Club 82 have become the prototypes for hundreds of others like them both in North America and abroad.

When the phenomenon first started a year ago, it was called a minor fad by critics, destined to die before the year was out. Die it didn't. In fact, it went on to become a growing business.

Nationwide, discotheques are increasing at the rate of 10 percent a month. In recognition of this, record companies have created departments that deal exclusively with producing records geared to a dance formula. These records are distributed to discotheque disk jockeys who monitor the public for reaction to the products even as they familiarize it to new sounds. Discotheques are rapidly becoming a testing ground for records, second only to radio.

The popularity of this dance sound can be traced to the oversaturation of the youth market by R&B and hard-rock products. Evidence is seen in dipping sales and empty seats at concerts.

This new sound can best be described as a synchromeshed blend that is heavy on rhythm, brass and lush vocals. In some ways, it is a marriage of progressive rock and R&B, designed to move bodies, with a corresponding downgrading of the importance of lyrics. As one can imagine, the sound lends itself well to maximum treble and bass settings. Since sound pressure is one of the prime animating

forces of the discotheque culture, the hardware that produces it merits some mention.

Another aspect of disco life is, of course, the unusual lighting effects used to set the mood. Several companies manufacture special lighting systems designed specifically for this purpose. One such company, Meteor Lighting Co., offers a sophisticated line including controllers, chasers, rotating prisms, strobes, etc. Adding color and action to the music intensifies the entire discotheque atmosphere.

SOUND SET-UP

The composition of a disco sound set-up is determined by two people: the owner and the audio dealer. The person who will run the equipment, the disc jockey, is rarely consulted. The owners of an about-to-be-opened discotheque in New York City may come to someone like Billy Bramble

of Atlantis Sound (one of the largest dealers in sound equipment on the East Coast) and tell him how much money they are willing to spend. "Usually it's around \$5,000," says Billy who heads Atlantis' disco equipment department, "and as a rule, they leave the selection of the equipment to us."

In a sound package, priority (money-wise) is given to amps, pre-amps, speakers and the mixers. Savings, if any, are to be made in turntables, cartridges, earphones, and the like.

POPULAR EQUIPMENT

Equipment used varies widely from



A ten channel, 1000-watt-per-channel, solid-state sequential switching device which is sound-triggered or operator-managed by an adjustable speed control.



Sound Workshop discole mk III



Bozak Model CMA-10-2D Stereo Mixer/Preamplifier

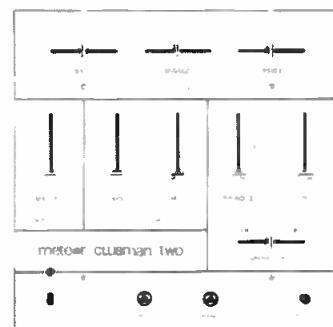

Stereo mixer pre-amp for discotheque use from Meteor Light and Sound.

Slavko Rebec hails from New York City's Greenwich Village

expanded hi-fi systems to truly professional installations. Popular speakers are: Bose 901s (especially in tight places where space is unavailable for floor-mounting speakers), Altec, JBL, and Cerwin-Vega.

The most commonly seen amplifier is the Phase Linear 400, followed by the Phase Linear 700B, Crown, and McIntosh units.

Mixers range from custom-built mixers to the Sony MX-14 which, although not expressly designed for this purpose, is extremely popular. The Bozak model CMA-10-2D is highly regarded and also extensively used in many clubs. GLI Industries, a New York based firm, has been selling a simplified, less expensive version that has achieved popularity. We understand that several newer mixers are soon to appear on the market—Sound Workshop and Disko Mix-Master have plans, but no data are yet available on these brands.

As for the equipment problems which disc jocks encounter, they nearly always boil down to management psychology regarding the sound equipment. In too many clubs, the equipment is looked upon as a necessary evil. Clientele relationship to sound quality and music is neither understood nor cared for. The disc

jock, who often is inexperienced, is responsible for both monitoring and maintaining the general health of the system.

Sometimes he has fairly inexpensive gear, which requires great care to keep it running. When he has to do this without the aid of spare parts and test equipment, one can appreciate his problems. In addition, the power is usually badly distributed, because most customers want their sound at super-pressure level. A \$5,000 economy package just doesn't have enough "guts" to handle the demand without a significant reduction in its life span.

Conditions would be more bearable if some of these owners provided an adequate repair budget and back-up system, but too often they don't. Caught in this crunch, most disc jocks regularly defect to more sound-conscious establishments as soon as the grapevine indicates that an opportunity is about to open.

One such place is the Sound Machine on New York's upper east side. They possess \$25,000 worth of audio hardware, including nine Altec Voice-of-the-Theater speakers, each with its separate amplifier; two theater-type brass horns for the super lows; four JBL tweeters for the super highs; an

Altec Acousta-Voice equalizer; and a panel of vu meters monitoring the speakers. The makers of this package, Rosner Custom Sound, of Long Island City, N.Y., gave disc jock Tony Palminteri (one of the founders of the disco craze phenomenon) plenty of power, range, and heavy-duty reliability for creating and blending sound.

NEW ACTIVITIES

Discotheques are increasingly getting into tape recorders, both for recycling the previous night's disco sounds (in a muted version) for daytime patrons, and as cassettes for car and home use.

The spreading discotheque craze has already spawned a mini discotheque kit for home and institutional application that is composed of: lights, dance records, and pictures put together as a package by Deca Dance Systems of New York City. It is under study at Playboy, UA, ABC and Warner Brothers records.

Record companies are beginning to invest in and to back discotheques. The big money infusion that this implies should mean better and more reliable equipment for disc jocks and a great increase in the audiophile population. ■



Neve

Neve has a baby!
New in the Neve family is little Kelso. Just look at what 24.8 inches of transportable, top quality mixing console gives you:

- 10 fully equalized inputs with conductive plastic faders
- 4 buses (2 program and 2 auxiliary)
- all of the same high performance standard
- 2 monitor outputs

Of course the handbook, spares and mating connectors are included. All this for under \$10,000.

CALL US

Rupert Neve Incorporated, Berkshire Industrial Park,
Bethel, Connecticut 06801 Tel: (203) 744-6230. Telex: 969638
Rupert Neve Incorporated, Suite 616,
1800 N. Highland Ave., Hollywood, California 90028 Tel: (213) 465-4822
Rupert Neve of Canada, Ltd., 2717 Rena Road,
Malton, Ontario L4T 3K1, Canada Tel: (416) 677-6611
Rupert Neve & Company Ltd., Cambridge House,
Melbourn, Royston, Hertfordshire, SG8 6AU England. Tel: (0763) 60776
Rupert Neve GmbH, 6100 Darmstadt Bismarckstrasse
114 West Germany. Tel (06151) 81764

Circle 32 on Reader Service Card

The Great Gain Getter!

The Universal Audio Model 560 Feedback Suppressor is a simple, compact, low-cost sound reinforcement tool for increasing gain before "howlback" in sound systems. Ideal for use in lecture halls, meeting rooms, schools and churches. Microphone or line-level input and output permits insertion between mike and amplifier or in line-level circuits. By centering the 560's four 1/6 octave notch filters on the system's most prominent resonant frequencies, gain can be increased up to 12 dB and intelligibility significantly improved. Each filter is tunable, 60 Hz to 6000 Hz in two ranges. Notch depth is adjustable to -20 dB.

The 560 can also improve more sophisticated broadband and/or 1/3 octave equalization methods by providing final "tweaking" of microphone proximity effects and troublesome residual resonances. So simple . . . so inexpensive . . . so, get one! UREI quality, of course.



UREI "Instrumental in Audio"

11922 Valerio Street, No. Hollywood, California 91605 (213) 764-1500
Exclusive export agent Gotham Export Corporation, New York

Circle 33 on Reader Service Card

CHEAP
—but not dirty



60 Watts—4.0 or 8.0 Ohms minimum sine wave continuous average power from 20 Hz to 20 kHz with less than .05% total harmonic distortion.

Our power amplifiers are some of the best available. Our prices are some of the most reasonable available. You may not be familiar with our products since we sell only by direct mail and don't advertise a great deal.

We would like to send you our new 1975 catalog showing all of our fine audio products and test report information on our famous "Tiger .01" shown above. You might be pleasantly surprised at how little clean power actually costs.

#207 Complete Kit \$ 77.50 Ppd

#207-A Assembled Amplifier....\$110.00 Ppd



Southwest Technical Products
219 W. Rhapsody
San Antonio, Texas 78216

Circle 46 on Reader Service Card

you write it

Many readers do not realize that they can also be writers for **db**. We are always seeking meaningful articles of any length. The subject matter can cover almost anything of interest and value to audio professionals.

You don't have to be an experienced writer to be published. But you do need the ability to express your idea fully, with adequate detail and information. Our editors will polish the story for you. We suggest you first submit an outline so that we can work with you in the development of the article.

You also don't have to be an artist, we'll re-do all drawings. This means we do need sufficient detail in your rough drawing or schematic so that our artists will understand what you want.

It can be prestigious to be published and it can be profitable too. All articles accepted for publication are purchased.

HARRY F. OLSON

High-Quality Monitor Loudspeakers

To achieve high-fidelity sound reproduction, you must understand and provide the required performance characteristics of a loudspeaker.

Reprinted from the December, 1967 issue of db.

WIDE frequency range, low distortion, uniform directivity and relatively high sound-power output loudspeakers are required for monitoring in radio and television broadcasting, phonograph and sound motion-picture recording, and high-quality sound systems. The performance criteria of the sound reproducing systems for these applications should satisfy the conditions required to provide high-fidelity sound reproduction. The purpose of this article is to define high-fidelity sound reproduction, describe the loudspeaker characteristics involved in achieving high-fidelity sound reproduction, give specifications of the loudspeaker performance characteristics and the means for providing the required performance characteristics in a loudspeaker.

Continued next page

In response to reader requests for technical data dealing with fundamental audio principles and practices, db Magazine is reprinting a number of outstanding articles from past issues, no longer available except on microfilm. Here is the first article in the series, called "The Best of db."

Performance Requirements For High-Fidelity Sound Reproduction

In the field of sound reproduction the term *high fidelity* is used to designate a quality of sound reproduction which provides a high order of realism.

To achieve this realism, that is high-fidelity sound reproduction, three fundamental conditions must be satisfied as follows:

1. The frequency range must be such as to include without frequency discrimination all the audible components of the various sounds to be reproduced.
2. The volume range must be such as to permit noiseless and distortionless reproduction of the entire range of intensity associated with the sounds.
3. The subjective aspects involving psycho-acoustic effects must be used in an appropriate manner in order to obtain a close artistic resemblance of the original rendition; these include loudness and dynamics, noise, auditory perspective and reverberation.

The elements of a sound reproducing system must exhibit such an order of excellence of performance so that the above conditions are satisfied if high-fidelity sound reproduction standards are to be met. The loudspeaker is one of the important elements of the sound reproducing chain. Its characteristics involved in achieving superior performance are: *frequency response, directivity, non-linear distortion, transient response, impedance, efficiency, and maximum sound-power output.*

Frequency Response

A loudspeaker's frequency response is the sound pressure on the axis as a function of the frequency.

The loudspeaker should provide uniform response over the frequency range from 30 to 15,000 Hz. For most high-quality applications the response should be contained within the limits depicted in fig. 1. In general, there is no problem in achieving this performance today in a high-quality loudspeaker. The procedure is to divide the frequency range into two or more parts and employ separate mechanisms for each range. This expedient makes it possible to achieve uniform response in both direct radiator and horn loudspeakers. However, some care must be exercised in the geometric configuration of the mechanisms to avoid deleteri-

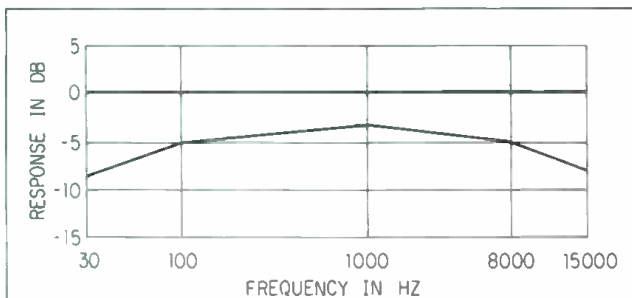

Fig. 1. A high-quality loudspeaker system should fall between these upper and lower limits of frequency response.

ous phase effects in overlap frequency regions due to a large physical separation compared to the wavelength between the mechanisms.

Directivity

The directional characteristic of a loudspeaker is its response as a function of the angle with respect to some reference axis of the system.

The directional patterns are usually depicted in polar coordinates. If the directivity pattern varies with frequency, frequency discrimination will occur for observation and listening points removed from the axis. Uniform directivity is particularly important in stereophonic sound reproduction in order to provide realistic auditory perspective.

Limits on the directivity pattern of a loudspeaker over the response range of 30 to 15,000 Hz are depicted in fig. 2. The polar curves should fall within the amplitude limits

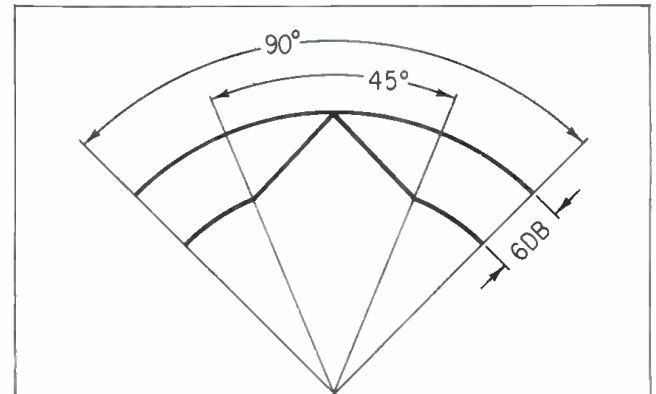

Fig. 2. The directivity pattern of a good speaker system should fall between these extremes over the 30 to 15,000 Hz range.

shown for an angle of at least 45°. For really high quality, the polar curves should fall within the amplitude limits shown for an angle of 90°.

The directivity pattern of a direct radiator loudspeaker can be controlled by the shape of the cone. The directivity pattern of horn loudspeakers can be controlled by the shape and design of the horn. An additional powerful means which can be employed to control the directivity pattern over the wide frequency range is the idea of dividing the frequency range into two or more sections. Additional expedients which may be employed to control the directivity are the use of diffractors, reflectors and acoustic lens.

Non-Linear Distortion

The non-linear distortion frequency characteristic of a loudspeaker is the total non-linear distortion as a function of the frequency.

The major result of non-linearity in the elements of the vibrating system of a direct radiator loudspeaker is the production of harmonics and subharmonics. Two major contributors to non-linear distortion in dynamic loudspeaker mechanisms are the driving and suspension elements. These elements are constant for small and moderate amplitudes but depart from constancy for large excursions of the cone or diaphragm. In the low-frequency range the amplitude of the cone in the direct-radiator loudspeaker must be inversely proportional to the square of the frequency and the amplitude of the diaphragm in the horn loudspeaker must be inversely proportional to the frequency in order to maintain constant output with respect

to frequency. Thus it will be seen that amplitude increases rapidly with a decrease of the frequency. For these large amplitudes there is considerable departure from linearity in the operation of the driving and suspension systems.

A typical non-linear-distortion frequency characteristic of a direct-radiator loudspeaker with non-linear driving and suspension systems for full output is depicted by

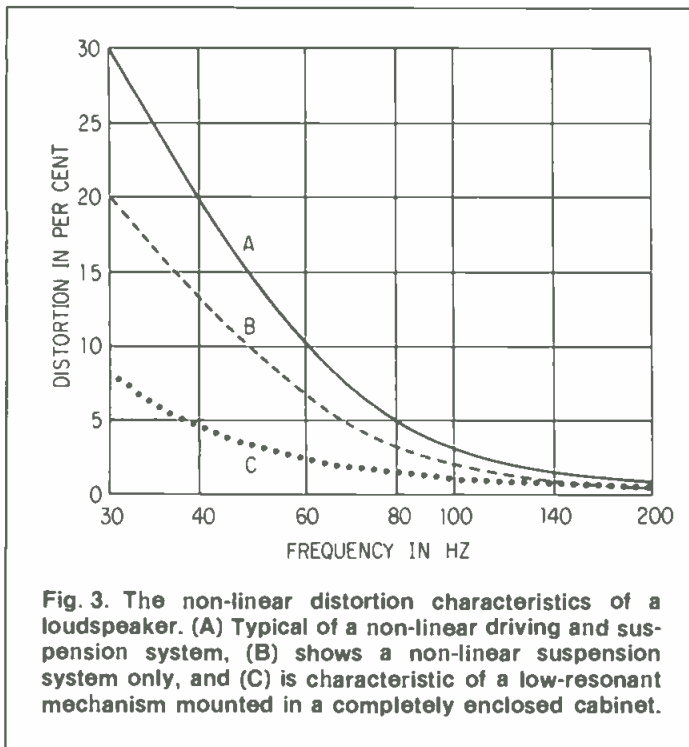

curve A of fig. 3. The distortion decreases as the power output decreases.

Distortion due to the non-linear driving system can be eliminated by employing a voice-coil design as depicted in fig. 4. In this configuration the flux-turns product

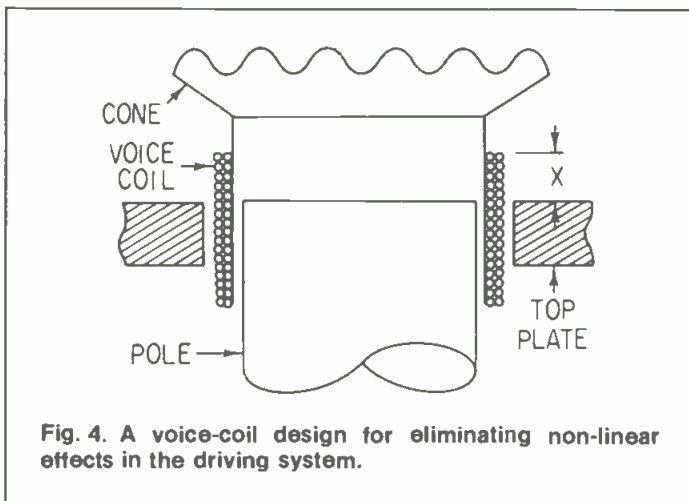

will be a constant if the amplitude of excursion is always less than x of fig. 4. The reduction in distortion by employing the expedient of fig. 4 is shown by the curve B of fig. 3.

Distortion due to the non-linear suspension system can be reduced by the use of a loudspeaker mechanism with a low resonant frequency and a completely enclosed cabinet in which the linear compliance of the air in the cabinet

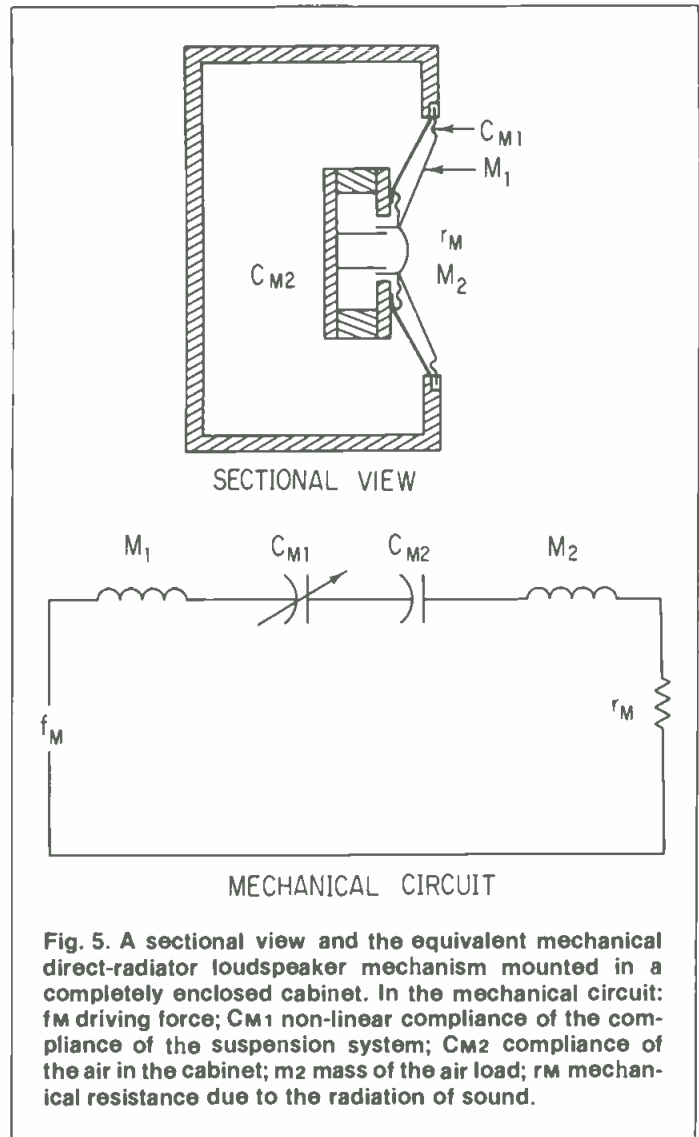

is the controlling compliance as shown in fig. 5. The mechanical circuit of fig. 5 depicts the method for reducing the deleterious effects of a non-linear suspension. The non-linear distortion is reduced to curve C by the use of the low-frequency-resonant loudspeaker mechanisms housed in a completely enclosed cabinet of fig. 5 and the voice-coil-design of fig. 4.

The cones and diaphragms of loudspeakers should be designed so that the operation falls within the limits of Hooke's law for the material and construction. This leads to a relatively heavy cone or diaphragm. This poses no problem except for a reduction in sensitivity. The subject of sensitivity will be discussed in a later section. Employing a heavy cone or diaphragm, the distortion in the frequency range above 200 Hz will be exceedingly low.

Transient Response

Transient response in a loudspeaker refers to the faithfulness of response of the loudspeaker to a sudden change in the electrical input.

For the most part the sounds of speech and music are of a transient rather than a steady-state character. Therefore, practically all sounds which are reproduced in a sound-reproducing system are of a transient nature. As a consequence, the transient response of a loudspeaker must be considered an important factor in the performance of the loudspeaker.

There are two general tests employed to depict the

transient response of a loudspeaker: the *square wave* and *tone burst*.

Figure 6 shows the amplitude response of a loudspeaker and tone-burst response. The tone-burst response is quite faithful in the smooth part of the amplitude range. However, there is considerable deviation of the tone-burst response at the peak and the dip. In general, in a properly designed loudspeaker, if the response of the loudspeaker is smooth the transient response will be good.

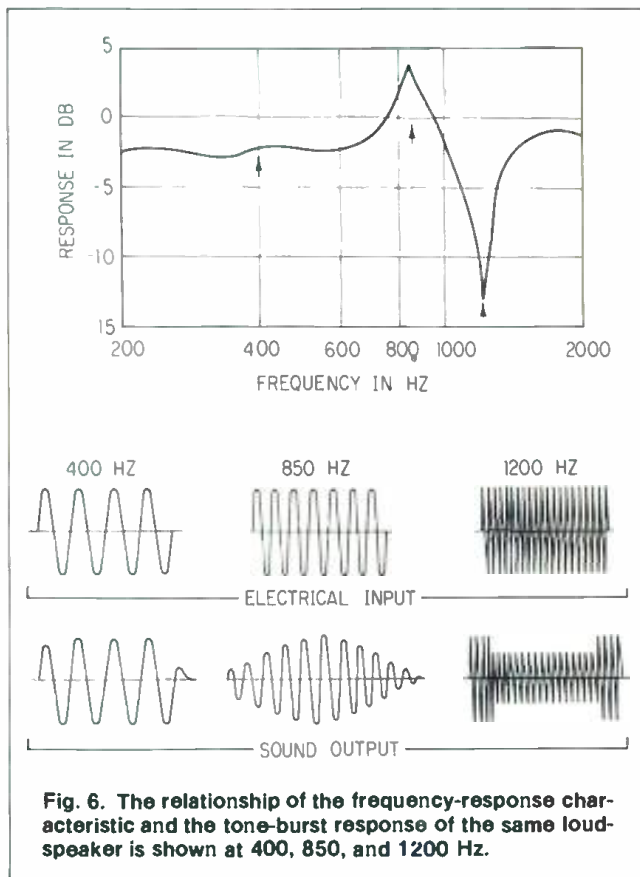

Fig. 6. The relationship of the frequency-response characteristic and the tone-burst response of the same loudspeaker is shown at 400, 850, and 1200 Hz.

Impedance

The frequency impedance characteristic is the electrical impedance of the loudspeaker as a function of frequency.

In the dynamic loudspeaker the variation with frequency is relatively small and there is normally no problem on the transfer of power from the amplifier to the loudspeaker.

Efficiency

The efficiency of a loudspeaker is the ratio of the sound-power output to electrical-power input.

For monitoring applications the low efficiency exhibited by most monitoring loudspeakers is of little concern because the maximum sound levels needed can be obtained with relatively modest amplifiers. However, for large-scale sound reproduction, as for example, sound reinforcing systems in large auditoriums, efficiency is a consideration if the amplifier requirements are not to become ridiculously large.

Maximum Sound Power Output

The maximum sound power output of a loudspeaker determines the level which the loudspeaker can deliver under a particular condition.

For monitoring purposes the loudspeaker should be

capable of delivering a level of at least 100 dB. The sound-power output required as a function of the room volume is shown in fig. 7. An alternate specification is 1 acoustic watt per 1000 square feet of area to be covered.

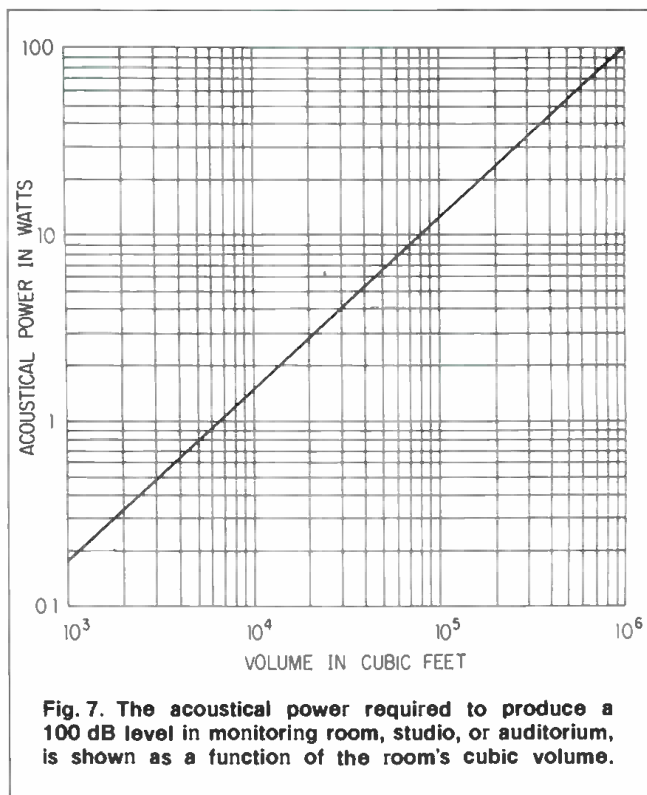

Fig. 7. The acoustical power required to produce a 100 dB level in monitoring room, studio, or auditorium, is shown as a function of the room's cubic volume.

These, in sum, are the performance characteristics used to determine high-quality loudspeakers for use in professional monitoring and sound systems. In general, this data represents the state of the loudspeaker art at this time.

Additional Comments

The loudspeakers used for professional sound applications are practically all of the dynamic type mechanism operating either as a direct radiator or horn driver. The main reasons for this state of affairs are as follows:

1. The mechanisms are relatively simple.
2. The mechanisms are comparatively easy to build.
3. The mechanisms are rugged and outlast some of the other electronic components.
4. The mechanisms are relatively reliable.
5. Very good performance characteristics can be obtained if there are no unreasonable limits on cost.

Loudspeakers are often accused of being the weakest link in the sound reproducing chain. The question arises, namely, if the performance of a loudspeaker is so terrible, why is it possible by means of subjective tests employing a loudspeaker to demonstrate a minor improvement in one of the other elements of the sound-reproducing system? As a specific example, why is it possible by means of listening tests to detect a difference in the performance of two power amplifiers of different designs, both flat to within a decibel from 20 to 20,000 Hz, both with distortion of a small fraction of a per cent up to 20 watts, and both with excellent transient response?

The answer is that the performance of a high-quality loudspeaker is pretty good for the various characteristics in the amplitude and frequency ranges that count. ■

SOLID STATE POWER AMPLIFIER



● Reliability problems encountered in drive-in theaters spurred the development of model 1590B/TH solid state power amplifier. The amplifier is rated at 200 watts at less than one percent total harmonic distortion from 50Hz to 12kHz. Strapped for 8 ohms, 35 volt operation, it has easily accessible strapping options for 16 ohm, 70 volt operation. The unit features silicon solid-state circuitry input connections for high-impedance devices and for 600-ohm or 15,000-ohm balanced inputs, and fail-safe protection for output transistors. 1590B/TH is capable of operation from a 120V or 240V a.c. source or a negative grounded

28V d.c. source. A trickle charging current maintains battery charge when the amplifier is operated in the a.c. mode. 1590B/TH is designed for rack-mounted use, occupying six units of vertical rack space.

Mfr: Altec Corp.

Circle 50 on Reader Service Card

THERMAL SPOT TESTER



● A small blower heater with an extension tube, the Thermal Spot is an electronic circuit fault detector. As it warms up to 260 degrees F. directed at a single spot, it heats up individual capacitors and transistors to find malfunctions that only appear when circuits are warmed. It can also be used

to spot dry epoxies or tuners and other components after cleaning.

Mfr: Wahl Clipper Corp.

Circle 51 on Reader Service Card

TAPE CARTRIDGE MACHINES



● Series 2000 Spotmaster tape cartridge machines have a claimed noise figure of over 57 dB and under 80 millisecond start/stop time. Features include balanced transformer output, 1000 Hz cue, 150 Hz cue and provision for remote control and telephone interface. Separate front panel plug-in modules are used to implement record and audition functions.

Mfr: Broadcast Electronics, Inc.

Price: Mono playback: \$465

Mono record/playback: \$675

Circle 52 on Reader Service Card

The Auto Flanger: first of its kind

The first commercially-made studio product using state-of-the-art charge-coupled, bucket brigade technology. Reel flanging at the push of a switch and the turn of a knob. . . Comb filter effects heretofore impossible without two solid tapedecks, a mixing console, and a careful engineer are now possible . . . at a clearly affordable price.

Implementing state-of-the-art technology in affordable packaging is our foremost objective in product development. Our R & D teams are committed to supplying the audio engineer with products combining imagination, technology, cost-effectiveness. . . Innovation.

MXR Innovations

277 North Goodman St.
Rochester, New York 14607

Circle 38 on Reader Service Card

MARTIN

THE WORLD'S LARGEST
ELECTRONIC EVERYTHING HOUSE
FOR THE PROFESSIONAL

The biggest "in-stock" inventory of professional audio/video equipment, parts and accessories—anywhere.

The Everything House has everything for the professional... broadcast, audio, video, sound reinforcement and hi-fi stereo components.

Quality products from over 200 leading manufacturers*... what you want, when you want it!

Consult Martin's specialists about installation... service... systems design... and sales for all your audio/video needs.



*Such as: AKG, Altec, Ampex, Crown, DBX, Dolby, J. B. Lansing, 3M, Shure, Neumann, Sony, Scully, McIntosh, Urei

Call or write for
a free catalog

MARTIN

Audio/Video

Circle 41 on Reader Service Card

320 West 46th Street, N.Y.C. 10036
(212) 541-5900

Clean up your church...

school, club, or business
sound system with the
new Electro-Voice
LR4B Line Radiator.™

The new Electro-Voice LR4B Line Radiator squarely meets the challenges of critical listeners and demanding users. You get wide-range, smooth response that makes everyone sound good... voice or music. And the coverage pattern from our unique multi-faceted design helps reduce feedback compared to less sophisticated column speakers. This means more useful gain is available when inexperienced performers get off-mike or don't speak up.

The LR4B is just one of the useful tools only E-V distributors have available for the thoughtful sound man. Ask your rep or contact us at the factory for full details.



Electro-Voice

ELECTRO-VOICE, INC., Dept. 556-BD
686 Cecil Street, Buchanan, Michigan 49107

a gulton
company

Circle 42 on Reader Service Card

new products & services (cont.)

F.M. STEREO TUNER



● Noise and distortion that have mixed with the signal during its transmission to the receiver can be reduced to below audible level by Accuphase T-101, according to the manufacturer. The unit's design has been concentrated on sharp selectivity for reception that requires critical separation and stresses lowest distortion for reception where there is no noise elimination problem. Multipath effects on input signal quality can be checked by an independent multipath meter. A signal strength meter and a center tuning meter are also provided. The front end is equipped with a frequency 4-gang variable capacitor, dual gate mos fet transistor circuitry, and local oscillator isolated by a buffer circuit. Performance includes wide dynamic range input, spurious signal rejection over 100dB and image rejection over 80 dB. Features include a variable selectivity i.f. circuit, a wide-band detector circuit, stereo-only switch, muting switch, and stereo noise filter. A tape deck can be connected directly to the fixed level output and an amplifier can be connected to the variable output.

Mfr: TEAC Corp.

Price: \$450.00.

Circle 53 on Reader Service Card

POLYURETHANE POTTING COMPOUND



● Sealing and potting compound ZT-POLY, with a gel time of ten minutes at room temperature and a tensile strength of 1735 psi and hardness of 55/55 is recommended for encapsulating wire or cable splices, etc. Packaged in 6, 8, and 20 ounce cartridges, the two-part compound is mixed with a pumping rod and dispensed by the rod as a lever. Available also in bulk.

Mfr: Zippertubing Co.

Circle 54 on Reader Service Card

AUDIO CONSOLE COMPONENT

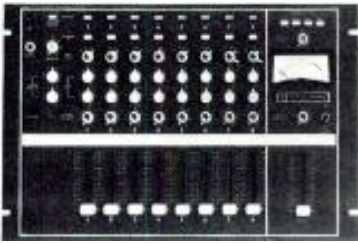

● Eight-channel rack-mountable mixer/preamplifier model SR101 console may be custom-installed in a desk or console, measures 12¼ x 19 x 6¾ inches. The unit accepts up to eight low impedance microphones, each with individual controls for volume, reverberation, high- and low-frequency equalization, and input attenuation. Switchable inputs on channels 7 and 8 also accept auxiliary high-level signals or high impedance mics. Model SR101 provides simultaneous program and monitor outputs, each controlled by its own master volume control. Program output has a 600-ohm balanced, line level output. The monitor output has a 600-ohm unbalanced, line level output and an eight-ohm output for mono or stereo headphones. Other features include: dual link jacks; master and individual linear-motion feedback-type channel volume

controls; master reverb in/out control; individual attenuators for each channel; four anti-feedback switches; lighted vU meter; kHz tone oscillator with its own volume control.

Mfr: Shure Bros.

Circle 55 on Reader Service Card

STEREO/PIANO AUDIO PICKUP



● Two transducers permit FS-200 to pick up two instruments or to offer improved pickup on piano. The device, which attaches with special inert adhesive wax, contains a preamp with an LRN-69 power supply, outputs for stereo and/or mixed mono, and built-in variable low frequency rolloffs for each channel, which can roll off the lows at 6 dB octave from approximately 30 to 300 Hz. FS-200 plugs into an a.c. outlet. Although designed primarily for piano, it can be used with other instruments.

Mfr: FRAP

Price: \$650.00

Circle 56 on Reader Service Card

WE HAVE ALL THE RIGHT CONNECTIONS.

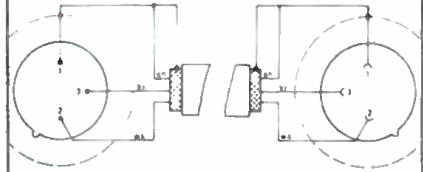

A "simple" microphone extension cable isn't so simple. Not if it's going to match today's phase accuracy and continuity requirements!

At Gotham, we start with double RF shielded, 3-conductor cables made to Neumann's tight specifications. And we attach Switchcraft "Q-G" (XLR compatible) connectors with a special technique, so the connector shell is grounded.

Our price? Practically what you'd pay for cable and plugs alone. Twenty-five feet, \$9.60. Fifty feet, \$14.96. One hundred feet, \$26.48. In small quantities. (12 or more.)

Order through your Neumann Microphone Dealer. Or from Gotham directly.

GOTHAM
AUDIO CORPORATION

741 Washington Street, New York, NY 10014
(Tel: 212-741-7411)
1710 N. La Brea Ave., Hollywood, CA 90046
(Tel: 213-874-4444)

Limited only by your imagination

you had a general purpose limiter with fast response, bridging input, low impedance output, instantaneous LED G.R. readout, and adjustable threshold, output and release time, attractively priced, imagine the many uses you could put it to. Think of all the transmitters that get over-modulated, all the lines that get over-driven, all of the tapes that get saturated, all the peaks that get clipped, all the mics that blasted. . . . The MXR Mini Limiter is very general purpose in its applications, compact in design, satiate in implementation, stereo strappable. . . and gloriously affordable.

Many simple problems—a simple solution. So much in keeping with MXR design objectives.

MXR Innovations 277 North Goodman St./Rochester, New York 14607

Circle 39 on Reader Service Card

AUDIOWAVES

The perfect beginning.
RCA Microphones

Sound decisions start with a microphone. That's why RCA offers a complete line.

There are velocity, pressure and dynamic mikes to choose from. And when you want particularly faithful reproduction of speech or music, RCA ribbon microphones, with their excellent bass response, are what you need.

See your RCA representative. It could be the perfect beginning of a sound relationship. RCA Broadcast Systems, Camden, N. J. 08102.

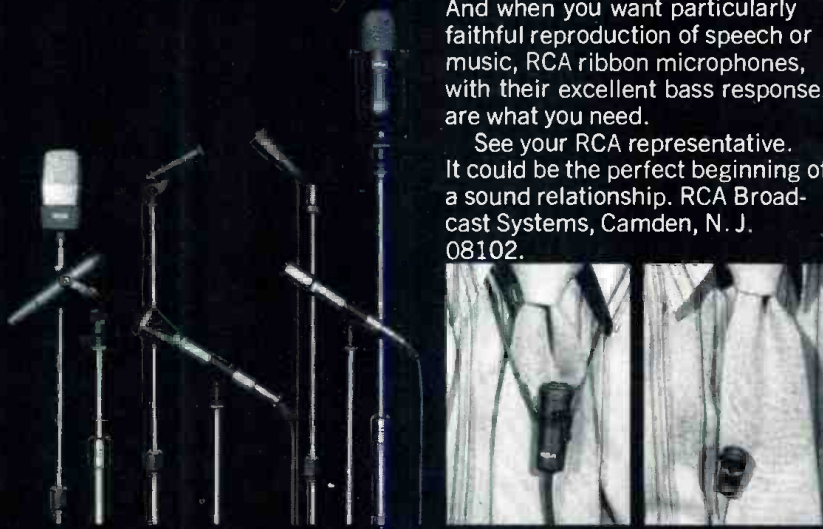

RCA

Microphones • Consoles • Tape and Transcription Equipment
Automation Systems • Amplifiers and Speakers

Circle 43 on Reader Service Card

new products & services (cont.)

MINIATURE CAR SPEAKER SYSTEM



● Designed for confined areas, such as vans, where only d.c. is available, model 2001 miniaturizes some high-power features. It contains a 4-inch diameter precision woofer and a soft-dome tweeter. A total of 160W of sine wave power is provided by four independent amplifiers, coupled with electronic crossover networks, equalizers, and opto-electronic limiters. The high power level is generated with the help of a new d.c./d.c. switching converter operating at 25kHz. The complete system consists of two speaker units 6 $\frac{7}{8}$ x 4 $\frac{1}{4}$ x 4 inches, and a power supply amplifier box measuring 3 $\frac{5}{8}$ x 10 x 9 $\frac{3}{8}$ inches.

Mfr: Analog & Digital Systems
Circle 57 on Reader Service Card

state-of-the-heart

YOU'LL LOVE ITS FEATURES!

PLUG-IN
REMOTE
CONTROL

INOVONICS MODEL 355



DUAL-CHANNEL TAPE ELECTRONICS: \$1320

This high-performance package is ideal for original installations or for upgrading existing systems.

- Features include:
- Conservative design criteria and distortion-reducing circuitry to assure highest quality recordings.
 - Capability for remote control of all recording and monitor functions.
 - Solid-state switching to eliminate punch-in and contact noise.
 - Individual SYNC and reproduce amplifiers for optimum SYNC performance.
 - Versatile 3-speed EQ for all NAB and IEC standards.

Check out the Model 355. You'll love its features and performance!
Call or write today.

i INOVONICS
INCORPORATED

1630 Dell Ave., Campbell, CA 95008

Phone: (408) 374-8300

Circle 44 on Reader Service Card

INDICATOR METERS

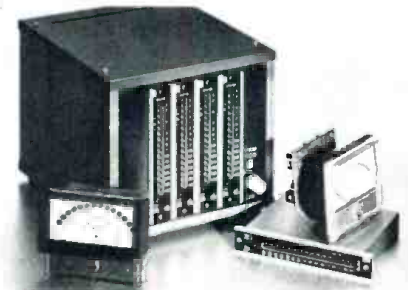

● Two new units have been added to this manufacturer's line of vertical scale and arc-scale meters. PK-100 has the same amplifier electronics as model PK-14/16, which converts conventional vu meters into peak level monitoring instruments. The circuit board module features simple attachment to existing meter terminals and mating connector, shallow behind-meter profile, accessible adjustments for electronic change of integration time, fall-back and tracking. Model PKM-400 has four independent channels of led, indicating level monitoring. Alternate mode PK-16 is utilized in a self-powered, small portable console top package. It features XLR input connectors and a built-in display brightness control.

Mfr: Quad/Eight Electronics
Circle 58 on Reader Service Card

OMNIPRESSOR



● New features announced by the manufacturer of model 2830 omni-pressor includes separate control of attack and release times; attack varies from 100 microseconds to 100 milliseconds and releases from 1 millisecond to 1 second, both continuously adjustable and calibrated. Model 2830's leds show instantaneous limiting which the meter cannot follow. The unit also has parabolically calibrated function control, allowing compression/expansion ratio adjustment without reference to meters. Input threshold control is adjustable over -25 to +15 dBm range, fully calibrated. There is complete control of compression and expansion ratio, including infinite compression, dynamic reversal, and selection of control range up to 60 dB. The device can be used as a fast limiter as well as a special effects and standard compressor.

Mfr: Eventide Clockworks, Inc.

Price: \$600.00.

Circle 59 on Reader Service Card

SPEAKER SYSTEM



● Model 5 is a medium efficiency system, designed for use with amplifiers of at least 30W rms per channel, up to 250W rms per channel. Model 5 is capable of handling musical input of 35-45V (320-412W). It uses an AGC 3 fuse; the filter network contains a fuse holder, as well as a spare fuse block. Frequency response is 32-20,000 Hz \pm 2dB. Impedance is 6 ohms. An optional asymmetrical pedestal is available to hold the 56-pound weight of the speaker.

Mfr: Rectilinear Research Corp.

Price: \$300.00.

Base: \$59.00 per pair.

Circle 60 on Reader Service Card

We take the wait out of erasing lots of tape

New Model 70 cleanly erases any 7" reel, cartridge, or cassette in one pass over the continuous belt. Your tapes will be as clean as new in 4 seconds. For audio, video, and data tapes.

GARNER INDUSTRIES
4200 North 48th Street, Lincoln, Nebraska 68504

Circle 45 on Reader Service Card

Phase in your studio

The MXR Auto Phaser can convert 10.5 square inches of unused board space into the most useful musical effect known to the modern recording engineer today, at an uncompromisingly low price. Internally contained sweep oscillator, power regulation and logarithmic amplifier teamed with external voltage control capability, and a dynamic range in excess of 100 decibels, make the Auto Phaser without par in the industry.

Phasing is rapidly becoming as commonplace today as reverberation. So very often many channels require individual simultaneous phasing effects, stereo enhancement and frequency modulation, until now unattractive due to cost and space limitations.—Freeing the creative imagination through technological innovation—

MXR Innovations Professional Products Group

277 North Goodman St./Rochester, New York 14607

Circle 40 on Reader Service Card

BE TMS 200 TURNTABLE PRE-AMPS



Versatility is the perfect description for our new BE TMS turntable pre-amps. For example, phase reversal on one channel gives five modes of stereo/mono operation including independent dual channel mono and mono playback of stereo recordings. Transformer output.

Spotmaster[®]

ALSO
CONSOLES
AND CARTRIDGE
MACHINES



BROADCAST ELECTRONICS
8810 Brookville Road
Silver Spring, Maryland 20910
Phone: 301-588-4983

Circle 2 on Reader Service Card

products & services (cont.)

MIDGET INDICATOR LIGHTS



● "Tynylites" indicator lights are intended for applications with miniaturized devices. The holder, which measures 7/8-inch in length, including 1/4-inch lugs, is sized to install in a 7/16-inch diameter hole with panel thickness up to 1/4-inch, on minimum centers of 23/32-inch. Front flange diameter is 17/32-inch and rear lock nut diameter is 41/64-inch. A spring-loaded center contact permits positive lamp contact. Bulb replacement is made through front access; a knurled front flange facilitates panel installation, using a matching socket wrench. The choice of incandescent bulbs includes a #162 lamp for 6-7 volts, #163 lamp for 21-24 volts, and #333 lamp for 24-28 volts. Two round or flat styles of lens caps are available in red, yellow, green, blue, white, and clear; cap styles with flat

facings may be hot stamped with letters or numerals.

Mfr: CM/Drake

Price: \$1.27 (1-9) units.

70¢ (1000-2499 quantities.)

Circle 62 on Reader Service Card

NON-CONTACT OPTICAL SWITCH

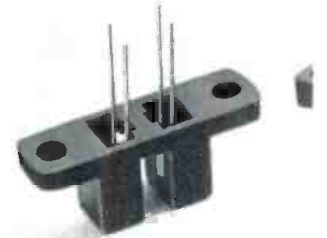

● This economy non-contact replacement for mechanical switches is an electro-optic solid state device. It incorporates an aperture detector that provides a high signal-to-noise ratio in ambient light and permits precise mechanical alignment. Four models are available, utilizing a phototransistor or photo Durlington, each with two different gain ranges. It is suggested for use in applications such as optical shaft position encoding, as a limit switch for mechanical travel, and as a counter.

Mfr: HEI, Inc.

Price: \$1.50 in quantities of 1,000

Circle 61 on Reader Service Card

"Freedom, Control & Economy."

The Orban/Parasound Parametric Equalizer, Model 621 costs just \$339/channel in the two-channel format. Yet it offers important features which its more expensive competitors lack. Up to 16dB boost is available, and the cut goes all the way to minus infinity. This, in addition to the availability of four totally non-interacting bands, means that the same equalizer can be used for simultaneous broadband equalization and notch filtering in recording, cinema, broadcast, or sound reinforcement. We have chosen to make our equalization curves "constant Q" rather than reciprocal. This way, extremes of equalization stay musically useful instead of becoming intolerably peaky and ringy.

Like the competition, we provide continuously variable tuning and equalization controls for each band. But unlike some others, we also provide continuously variable bandwidth control. And each band's tuning range of 4.3 octaves with constant bandwidth yields broad overlaps between bands to further increase versatility.

Add low noise and distortion, front-panel gain control, click-free in/out switching, peak-stretching overload light,

and extensive human engineering, and you've got the most cost-effective professional equalizer available today—one that offers almost limitless freedom and control over sonic timbre. The Orban/Parasound 621 Parametric gives you the power to get things really right.

Also inquire about our Spring Reverb, Dynamic Sibilance Controller, and Stereo Synthesizer.

For further information, contact

orban/parasound

680 Beach St., San Francisco, Ca. 94109
(415) 776-2808 or your local
Orban/Parasound distributor.

The Orban/Parasound Parametric Equalizer.
The Price Performance Leader

Circle 18 on Reader Service Card

HIGH POWER AMPLIFIER



● Monaural, single-channel amplifier model M-600 has been designed to meet the demands of high power amplification. M-600 amplifier signals from d.c. to 20kHz and provides 70 volt unbalanced line output at 600 watts of continuous power into 8 ohms and 1,000 watts into 4 ohms, indefinitely. The amplifier contains built-in cooling, which permits continuous full power operation. A two-speed fans shifts to high speed if heat sinks exceed 140 degrees F., the amplifier shuts down to standby mode if the sink temperature exceeds 160 degrees F. and then automatically reactivates when temperature drops down below 160 degrees F. A changeable, plug-in input board enables the unit to drive any type of input load, including a pure reactance, without adverse effects. Modifications to the board can be used to add filtering, preamplification, mixing, and constant current sensing. An output bridge circuit is designed to permit extremely high power levels to be safely sustained for ultra high power applications. It is possible to couple two M-600s together through a socket at the back of each amplifier.

Mfr: Crown International
Circle 63 on Reader Service Card

FOUR-CHANNEL LIMITERS



● This modular item fits into a double module space in the manufacturer's model 10 console. Designated L-100T and L-150T, the limiters use LEDs to give rapid response in limiting threshold indication. Each channel of the L-150T limiter/compressor has controls for input level, output level, attack and release times, and compression ratio. In addition to giving pro-

tection from transient overload, the unit allows the shaping of dynamics. Through the use of the attack and release controls, the engineer may allow some transients to pass unlimited to retain dramatic impact and still compress to give maximum sound power to the material. L-100T, the basic 4-channel unit, has fixed rather than variable compression, attack, and release times. It provides high ratio peak limiting aimed at leaving the bulk of the program material unaffected and protecting from transient overload saturation.

Mfr: Sound Genesis
Circle 64 on Reader Service Card

TURNTABLE PREAMPS

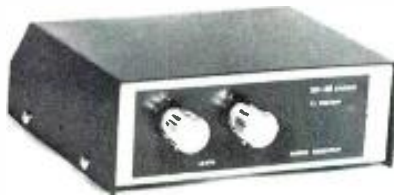

● High sensitivity, inaudible distortion and RFI suppression are claimed by the manufacturer of E series turntable preamps. MP-8E (mono) and SP-8E (stereo/dual mono) provide at least +4dBm-out with as little as

500uV-in at 1kHz. Adjustments are provided to enable the preamps to accept up to 100mV-in before distorting. The units have rear terminals for remotely switching to one of three modes of operation: RIAA response \pm dB, scratch filter, or brilliance boost. The series features balanced 600 ohm outputs capable of at least +21dBm-out, signal/noise ratio of -77dB, distortion of less than 0.05 percent and greater than 70dB channel separation. The units contain their own internal power supply and may be either table-top or bracket mounted.

Mfr: Ramko Research
Price: SP-8E: \$137.00
MP-8E: \$86.00.

Circle 65 on Reader Service Card

**36 types of
empty tape reels
and boxes**

**for hi-speed duplicating
audio spots - tv spots**

IMMEDIATE SHIPMENT
FROM MANUFACTURER'S STOCK

GET CATALOG PD 175

Polyline CORP. 312/298-5300
1241 Rand Rd. DesPlaines, IL 60016

Circle 49 on Reader Service Card



Ask anyone.

Motion Picture Sync Systems

The need to synchronize sight and sound has generated ingenious applications of mechanics and electronics.

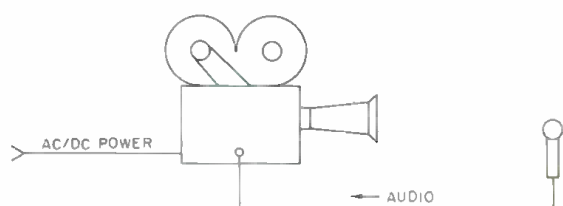

Figure 1. Single system.

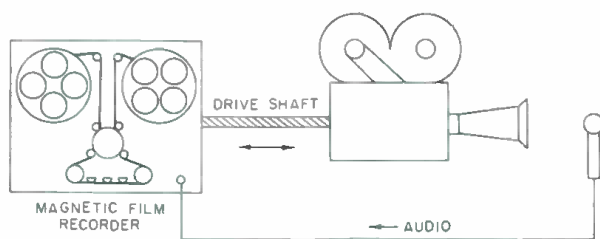

Figure 2. Mechanical interlock.

EVER SINCE sound was added to motion pictures, filmmakers have been challenged by the necessity of keeping picture and sound accurately synchronized. There are basically three systems for recording synchronous sound, either on location or in the studio.

1. *Single System.* The sound is recorded directly on the original camera film, either as an optical sound track or on film which has been magnetically stripped by the manufacturer. Magnetic 16 mm single system is common in newsreel and documentary filming.

2. *Double System (Sprocketed).* This system was used primarily in studio filming, but is now rarely seen except in special circumstances. It involves the use of a recorder designed to operate with 16 mm sprocketed magnetic film running at 36 f.p.m., 35 mm magnetic film at 90 f.p.m., or 17.5 mm magnetic film at 45 f.p.m.

3. *Double System (Non-Sprocketed).* This relatively recent innovation, often called the "pilotone" system, has rapidly replaced the first two systems in nearly all cases except news production. Audio is recorded on standard tape in the conventional manner. But instead of using perforation holes, a "sync pulse" representing variations of camera speed is recorded on either a separate track, as in the case of multi-track sync recording, or superimposed over the audio track area, as in the Rangertone, Perfectone or Neopilot systems. This sync pulse track can also carry information for slates (start marks) and scene identification.

SINGLE SYSTEM

Single system sound (FIGURE 1) is, by its very nature, self-synchronizing, providing the camera is properly threaded. As currently used in 16 mm filmmaking, the film passes either an optical film gate or a magnetic recording head exactly 26 frames after it passes through the photographic aperture. In magnetic newsreel cameras there is also a playback head located one or two frames after the record head to allow the recordist to monitor the recording properly. To play back an optical single system recording, one must wait until the film has been processed.

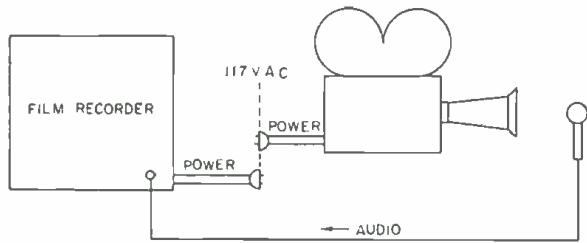

Figure 3. A.C. line sync.

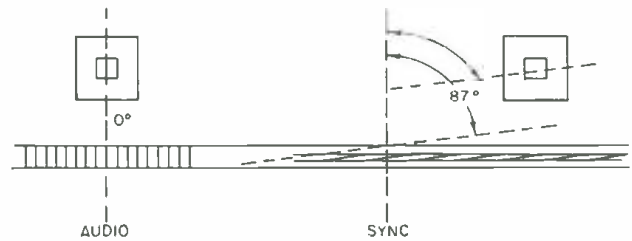

Figure 4-B. Rangertone head and track.

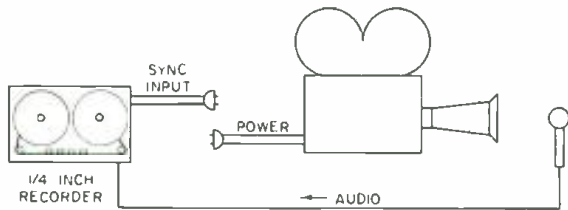

Figure 4-A. Rangertone System.



Figure 5. Perfectone head and track.

DOUBLE SYSTEM (SPROCKETED)

The simplest double system sound equipment requires a direct mechanical connection between the camera and a sprocketed magnetic film recorder (FIGURE 2). As the camera's motor advances the film one frame, a shaft connecting the camera and recorder rotates and advances the recorder's sprocket by one frame. By connecting the shaft to the camera's motor rather than to the intermittent camera movement and by employing the appropriate reduction gears, the shaft's rotation will be continuous, which is necessary for flutter-free recording. If the camera speed varies, so does the recorder speed, and frame-by-frame synchronization is therefore maintained.

Since it is quite impractical to keep a bulky recorder within a few inches of the camera at all times (especially during hand-held shots) an electrical counterpart to the direct drive was invented. If an a.c. synchronous motor is operated within the proper load and voltage parameters, its rotation will precisely follow the frequency variations of the supply voltage as long as the variations are neither too sudden nor too severe. With similar synchronous motors on both the camera and the sprocketed film recorder, each machine will be "locked-in" to the sync of the power line (FIGURE 3). If both machines are connected to the same a.c. source, they will run in perfect synchronization. To label the start of each take (the recorder and camera drop out of sync the moment either is switched off of the a.c. line), a *slate* is employed. The first picture frame in which the editor sees the slate's clapstick fully closed will correspond to the frame in which the clap is heard on the sound track. This requires that both the camera and the recorder are running at speed and are locked-in to the a.c. line before the slate is clapped.

DOUBLE SYSTEM (NON-SPROCKETED)

With the invention of high-quality 1/4-in. portable tape recorders, designers searched for an electronic system to eliminate the bulky and expensive sprocketed magnetic film recording systems.

The original Rangertone concept (FIGURE 4) involved running the camera from the a.c. mains and recording that

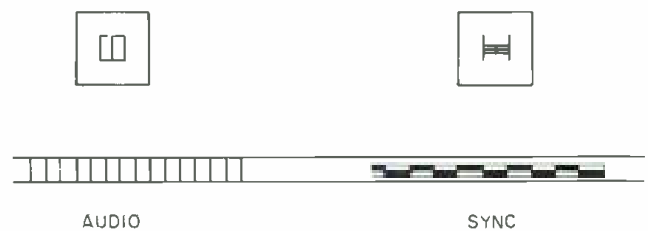

Figure 6. Neopilot head and track.

same a.c. signal (at a much lower voltage) on the 1/4-in. tape, parallel to the audio signal. This system resulted in a 1/4-in. tape with invisible magnetic "sprocket holes" recorded along the center of the tape in a special sync pulse track. As the camera speed varied due to fluctuations in the a.c. line frequency, the distance between corresponding sync pulses varied accordingly.

This system not only accounted for changes in camera operation, but also for any effects of uneven recorder operation or tape-stretching. Instead of recording these 60-Hz pulses on a separate track alongside the audio track, the Rangertone recorders used a separate sync pulse head which was rotated 87 degrees out of alignment with respect to the other heads. The intention of having the sync head so drastically out of alignment was to avoid reproducing the 60-Hz signal along with the audio track by a standard full-track playback head. But it was not entirely successful.

The Perfectone system (FIGURE 5) was an improvement over the Rangertone system. Two heads recorded identical sync pulses along opposite edges of the tape. However, they were staggered by the necessary distance so that a 60-Hz signal recorded by both heads at a tape speed of exactly 7 1/2 in./sec. would result in the tracks being exactly 180 degrees out of phase with one another at any point on the tape. Such a sync track, therefore, was inaudible when reproduced by a full-track head but entirely recoverable when played back with heads spaced similarly to those used during recording. Although the Perfectone system was an improvement, whenever the sync frequency or the tape speed changed such that the two sync tracks were less than 180 degrees out of phase, the sync track

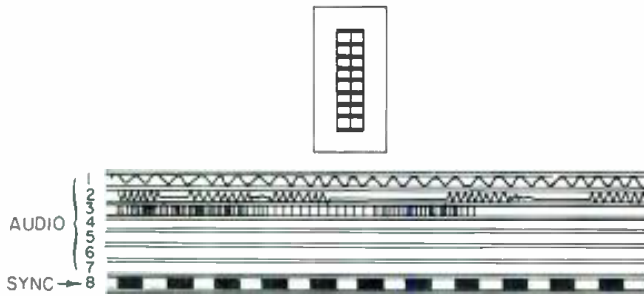

Figure 7. Multitrack sync.

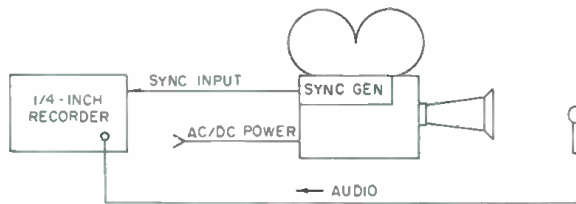

Figure 8. Camera sync.

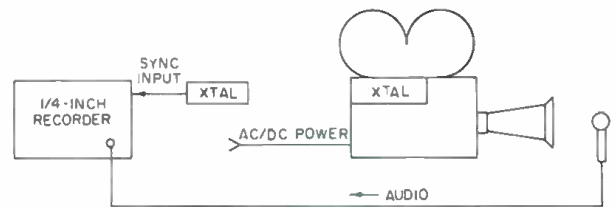

Figure 9. Crystal sync.

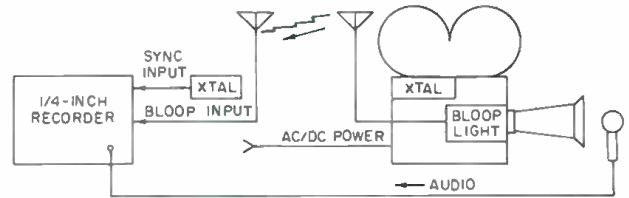

Figure 10. Bloop.

became partially audible at the full-track head, creating distortion and crosstalk during playback.

The third and now universally accepted refinement sync system is called Neopilot and was first used in the Nagra recorders (FIGURE 6). Very similar in concept to the Perfectone heads, the Neopilot system uses two narrow-track heads which, though wired out of phase with each other, occupy the same horizontal space in the 1/4-in. tape. Although this sync signal can be fully recovered by a head of this design, the narrow "push-pull" sync tracks recorded side by side along the center of the tape are totally inaudible during playback with a conventional full-track head. And, they are not susceptible to the effects of tape stretch or fluctuations in tape speed.

MULTIPLE TRACK RECORDING

For multiple track recording, as in musical films, a standard 4-, 8-, or 16-track recorder is used with the 60-Hz sync pulse assigned to one track. (FIGURE 7). If the multi-track master tape is later dubbed to 1/4-in., the sync pulse can be transferred at the same time to a Neopilot sync pulse to maintain perfect sync.

When the camera is not run from the a.c. mains, but from an independent supply such as batteries, a 60 Hz:24 frames/second generator can be connected to the camera's motor shaft (FIGURE 8). Serving the same purpose as a.c. line sync, the output of this generator can be fed directly into the recorder's sync pulse input (1-2 volts a.c., nominally).

CRYSTAL SYNC

After reducing sync-sound equipment to hand-held, battery-driven cameras and battery-powered, portable recorders, designers still wanted to eliminate the umbilical cable between the recorder and the camera or a.c. line. An extremely accurate 60-Hz oscillator controlled by a quartz crystal was designed in conjunction with crystal-controlled motors for popular hand-held cameras (FIGURE 9). With the camera running at exactly 24 f.p.s. under its own independent crystal control, the recordist can feed the output of his 60-Hz crystal oscillator into the recorder's sync input as though it were the output of the camera's own sync pulse generator. Sync is maintained within 1/4

frame in 400 ft. of 16 mm film (over 10 min.) with most good systems.

FAIRCHILD SYNC

There is a fifth sync system often used in studio recording known as Fairchild sync. A 14 kHz carrier is modulated by the 60 Hz sync pulse, mixed with the audio, and recorded on any track. During playback, the audio is passed through a low-pass filter, while sync is recovered through a high-pass filter and is then demodulated.

START MARKERS

Instead of using a slate to establish sync at the beginning of a take, an extra conductor can be added to the sync cable between the camera sync generator and the recorder to carry start-mark information (FIGURE 10). As the camera is started, a relay in the camera closes which powers a small bloop light or l.e.d. that exposes the film at the camera's aperture. It also places a 1 kHz tone on the sound track. When the camera motor is up to speed, the relay opens, switching off both the light and the tone simultaneously. At that moment, perfect synchronization is established.

This start-mark system can be a life-saver, especially in documentary filming. It has one disadvantage, however, of eliminating the scene identification usually accompanying the traditional clapstick. Unless a slate is photographed and read aloud onto the sound track it is difficult to identify later which piece of sound track belongs with which piece of film.

When using crystal sync there is no umbilical cord to carry such a bloop signal so this start-mark system can be replaced by a radio-operated bloop (FIGURE 11). The same relay contacts that normally send the bloop pulse to the recorder through the sync cable now send the same signal by radio. A small transmitter on the camera activates a receiver in the recorder when the camera start button is pushed, which in turn activates the 1 kHz bloop oscillator.

In documentary filming, when the recorder is often left running continuously while the cameraman turns his camera on and off, the resulting bloop tone can destroy valu-

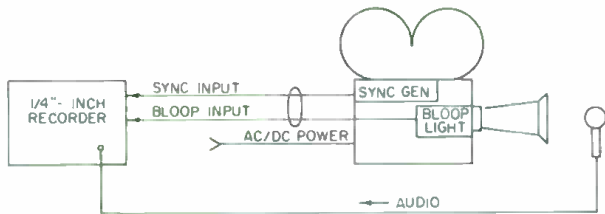

Figure 11. Radio slate.

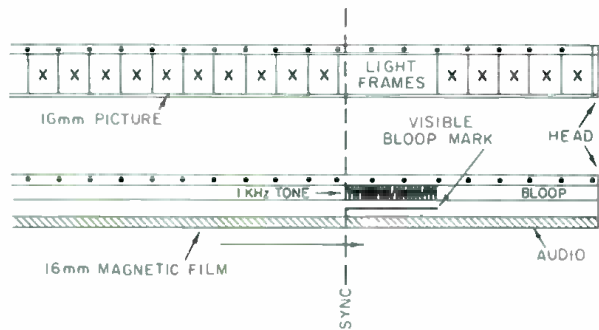

Figure 12. Silent bloop.

able portions of the sound track, so some portable recorders use a different bloop system. Instead of recording a 1 kHz tone on the sound-track portion of the tape, the camera relay triggers a second relay in the recorder which switches off the crystal sync oscillator as it switches on the camera's bloop light. During transfer to sprocketed magnetic film, the transfer equipment senses this brief interruption of the sync pulse, interprets this void as a bloop, and places a visible mark on the magnetic film at that point. It can also place a bloop tone on the magnetic film on a different portion than that being used for the audio (FIGURE 12).

In multiple camera filming, if transmitters and relays are designed to operate for a different length of time for each camera, the editor can easily tell which of the cameras was started at each start mark by measuring the length of the bloop on the sound track.

WHAT RESOLVING ENTAILS

If the sound has been recorded via single system, it is in sync with the picture as soon as the film is processed. If it was recorded on sprocketed magnetic film, it simply has to be "synced up" by aligning the picture and sound start-marks for each take. However, if the sound was recorded on 1/4-in. tape, it must first be transferred to magnetic film. The process of retaining sync during the transfer operation is known as "resolving."

The simplest resolver is a 200W audio amplifier that amplifies the playback of the sync pulse to 120V and drives a synchronous motor on a sprocketed magnetic film recorder (FIGURE 13). For every 60-sync pulse on the 1/4-in. tape, the recorder will advance the magnetic film 24 frames. If the camera slowed down during shooting, the sync pulses will be farther apart on the 1/4-in. tape and will reproduce at a frequency lower than 60 Hz which, in turn, will slow down the sprocketed recorder proportionally.

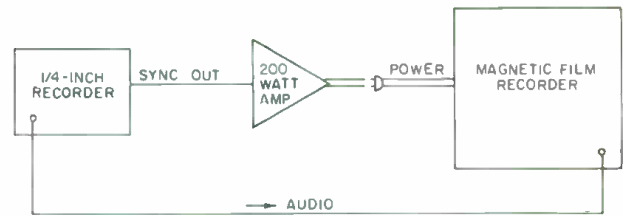

Figure 13. Simple resolver.

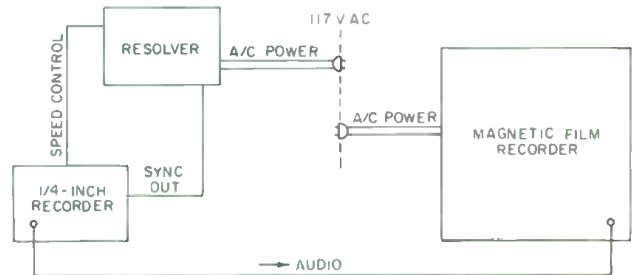

Figure 14. A more sophisticated resolver.

One major disadvantage of this system is that the sync pulses must be recorded on the 1/4-in. tape for many seconds before the usable portion of the scene in order to allow the film recorder time to get up to synchronous speed. Another is that the large masses used to drive magnetic film recorders cause them to respond slowly to changes in speed. And a third is that if pilot cutout start-marks are used during shooting, power to the magnetic film recorder will be interrupted at those points on the tape and sync will be lost.

The most common resolvers today use a more sophisticated and reliable system (FIGURE 14). The magnetic film recorder is run by a synchronous motor powered directly from the a.c. mains. The speed of the motor in the 1/4-in. playback machine is controlled by a resolver which contains a bridge comparator circuit. The bridge compares the phase of the a.c. mains driving the magnetic film recorder with the phase of the sync pulses coming from the playback machine. If the a.c. mains is 60 Hz and the sync pulses are 60 Hz, no motor speed adjustment is made.

If the sync pulses slow to 59 Hz (representing a camera slowdown, tape stretch, etc.) the resolver output increases, thereby speeding up the 1/4-in. playback machine until the sync pulses are again in phase with the main's frequency of 60 Hz. Unless there were sudden changes in sync frequency during shooting, this process of resolving results in no audible distortion of pitch and no loss of sync. This system works equally well whether the sync pulse was taken from the camera's sync generator, the a.c. line or a crystal oscillator.

These are, as usual, endless variations of all of these sync systems, such as using a radio link for sending the sync pulse as well as the bloop signal from the camera to recorder, and even radio systems which allow two-way communications between the cameraman and soundman during shooting. In many countries the standard is 50 Hz and 25 f.p.s. rather than 60 Hz and 24 f.p.s. However, these systems operate in identical fashion to the systems described here, and as long as you know which standard you are using, you should have no difficulty. ■

LARRY ZIDE

db Visits

Audiomatic in Paris

Audiomatic's expansion is marked by efficiency and competence that will enable it to meet growing sales on the Continent as well as abroad.

AS IF I even needed an excuse to come to Paris, France, an invitation to see what Audiomatic is doing in that city was one I couldn't refuse. So, off to Kennedy International for an Air France 747, and a few hours and one-third of a day later, I was debarking at Orly. There I was met by Serge Doubine, Audiomatic's young directeur-commercial for Audio in Europe, who was to be my host and guide through Audiomatic's operation in Paris.

As a company, Audiomatic has had an interesting history, and from my view, is moving toward an even more interesting future. It was formed in 1947 by Milton G. Gelfand (who had already been working as a chemist in the plating department of a record plant) and three partners. The name then was Audio Matrix, Inc, and its lo-

cation was the Bronx in N.Y.C. Five years later Milt Gelfand had bought out his partners and was sole owner. At that time, the record industry was producing only 78-rpm discs pressed from copper stampers, using nickel only as a flash, surface coating.

The emergence of the long-playing disc and 45 in the mid-50's created important new technological demands throughout the record-making process. Audio Matrix pioneered new techniques to meet the sophisticated needs of the pure vinyl long-play record. He was the first to convert to all-nickel masters and mothers. The company was the first to process stereo records and the first to use chlorides in a nickel sulfamate bath for the production of record plates without any increase in stress.

HIGH SPEED NICKEL-PLATING

As it adapted to the new requirements of the industry, Audio Matrix steadily evolved a high-speed nickel-plating system with so many new features that it was finally patented under the new name, *Audiomatic Process*.

At about this time (the early 1960's) tape was emerging as a dramatic new factor in the audio industry. Two friends, Allen Weintraub and the late Dan Cronin, had set up A&B Duplicators, for which they had designed and built an 8-track, high-speed tape duplicator. They were soon in a position with equipment similar to the tape industry as Milt Gelfand's Audiomatic Process had to the record industry. They decided that Weintraub and Cronin would manufacture equipment and Gelfand would sell it. As the business grew, two separate and totally non-interlocked corporations were set up for these purposes. Audiomatic was established for sales, and ElectroSound for the manufacture of tape-duplicating equipment. They remain two separate, distinct companies today.

The ensuing years have seen rapid growth by Audiomatic. The exclusive contract as international sales representative for ElectroSound led Milt Gelfand to set up



The ElectroSound master and duplicators.



A close-up of the third-reel equipped tape deck.

representatives and sub-distributors at strategic points throughout the world.

The past two years have seen significant growth steps by Audiomatic. In early 1973, Timothy A. Cole joined Audiomatic as vice president, bringing to the company a strong background in production equipment design and in the manufacture of records and tapes. In October of 1973, Audiomatic set up an office and showroom in Paris under the direction of Serge Doubine.

SET UP OFFICE IN PARIS

The formal opening of this new Paris office-showroom was in May, 1974, and it attracted 150 leading production executives from seventeen countries, all of whom traveled at their own expense to see what Audiomatic was selling.

What they saw and heard includes these companies that Audiomatic exclusively represents: Hamilton record presses, Shape Symmetry & Sun's automated cassette assembly systems, Apex on-cassette printer, and Graham-Fraser automated cartridge inserting equipment. And, of course, there was both Audiomatic's own record-processing equipment and ElectroSound duplicators and recorders.

My arrival several months later found some of this equipment missing (sold), and, in general, the place nicely furnished for both a sales and service center for Europe (excluding Britain, which has Lee Engineering as a sub-distributor). Nevertheless, Serge finds himself covering all of Europe, including Britain, with the complete lines.

The office-showroom suite at 4, rue Ficatier—92400 Courbevoie, contains a small office and demo room, and a larger showroom. About \$25,000 worth of spare parts line the walls, and tiny cubicles contain transistors that even might be hard to get locally. The result is that downtime on routine repairs anywhere in Europe can be held to a day.

I've seen a lot of plants and distribution operations so that I don't get impressed easily, but I was struck by the efficiency and competence that Serge Doubine exhibits. The sensible expansion of Audiomatic seems to be strong one for both the continuing growth of European sales and the expansion of both U.S. and world markets as well.

I went on a most interesting side trip with Serge Doubine to Pathé-Marconi (EMI-France), where I was shown some Audiomatic-supplied equipment in operation. Pathé has extensive tape-duplicating facilities at the plant we visited, as well as an Apex on-cassette printer. When you get to Paris, be sure to look up Audiomatic and M. Doubine. ■



Serge Doubine starts up an ElectroSound recorder that features a third-reel capability for editing.



This view, taken at Pathé-Marconi, shows one of the duplicator lines using ElectroSound equipment.

A Systematic Approach to Wiring Connectors

The Cascaded Potential System follows the rule that the lowest potential shall appear on the lowest numbered pin—with some qualifying rules to go along.

DURING THE EONS that I have been involved in audio, I have worked out a systematic approach to wiring things. I call it the cascaded potential system (CPS). This system, you must realize, will never be perfect, but it does offer a rational approach. The CPS is easy to remember and apply. And, newcomers can readily settle into CPS-wired studios.

The system revolves around the principle: "The lowest potential shall appear on the lowest number pin." There are some rules which qualify this, as for example, the following that have evolved to date:

1. Ground shall be considered to have the lowest potential of anything.
2. The negative phase line of a balanced line shall be considered to have less potential than the plus side.
3. In d.c. power, the negative voltage lines have less potential than plus lines and supply common is not ground.
4. You do not break the logical grouping of leads.
5. AAA is greater than AA which is greater than A, and $A = 1$, with number 1 being less than number $1 + n$, given n as a positive real number. ($n \neq 0$)
6. Multi-pair audio cables shall not have their shields separated from each pair, e.g.:
 (sh — +, sh — +, sh — +, etc.)
 NOT—(sh sh sh, —, +++, etc.)
7. On multi-pair audio, the pair having channel one data shall be considered to have less potential than a pair designated channel $1 + n$.

DIAGRAMS OF SOME CHOICE CONNECTORS

XLR

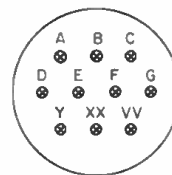

Screwy, isn't it?

MS—E/R
astro 348

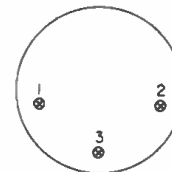

Remember rule #5
(good connector)

RECTANGULAR CONNECTORS

(rotten connectors)

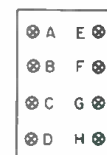

8. Any cable not adhering to CPS (where impossible) shall have a cable lay sheet with copies on engineering file and (if possible) folded up inside the connector shell or cabinet.

EXPLAINING THE RULES

Boggle your mind? I'll explain. Rule one is self explanatory. But what if you have more than one ground? Take technical and electrical ground—it is more or less decided that the dirty ground has more potential than the technical ground. This allows you to get the dirty electrical ground away from your signal lines by placing it on a more distant pin. That should not worry you since it is very seldom you would run a noisy ground in the same connector as a technical ground.

Number two is a kind of catchall that gets those screwed up XLR connectors and the like. It just says that the minus line should be assigned a smaller number than the plus line. That seems logical enough? The thing that hangs us up is the XLR numbering. They really numbered it 1, 3, 2, when you look at it in order. When you wire to CPS standard your *whole* system will be out of phase with what Electro Voice and others use.

Of course, they are unconsciously using the CPS, but in looking at the pin numbers they do not take it literally. This is something you must do in the CPS. If it is numbered 1, 2, 3 you wire it as such. Maybe Cannon will make a special run of XLR numbered 1, 2, 3 instead of 1, 3, 2. Anyway, don't worry. Phase is only relative—ask Einstein!

Number three is okay until you read the "common is not ground" part. All it means is that when you have multiple power supplies, you keep the common lead near the wires of which it is part. Some diagrams:

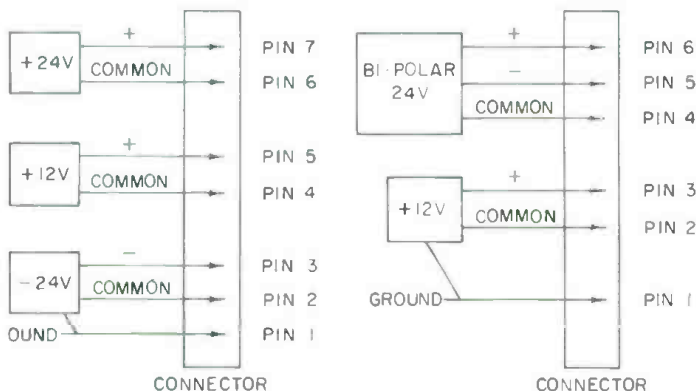

Rule number six is somewhat an extension of rule number five. It simply gives a logical touch to the wiring of multipair cables. Number seven just says that the pair with mic #1 should go to pins A, B, C on the plug.

Rules are meant to be broken. So, in keeping with tradition, is rule eight. This tells you that if you find it is awkward because of arc-over or something, and you don't want to use the CPS, that you'd better make sure you write down what you do on paper and file it in a *few* places. Sometimes you can squish one copy right into the connector shell or cabinet.

I have probably forgotten to mention a few rules, and some of you must make or modify rules to fit your problems. But here I have laid out the ground rules for a system we use which has proved to be most satisfactory over the years.

STOCK REDUCTION CLEARANCE!

CETEC IS CLEARING THE SHELVES OF OUR LANGEVIN & ELECTRODYNE SPECIAL ITEMS. YOUR CHANCE TO PICK UP THESE ITEMS AT A SAVINGS DURING THIS ONE TIME SALE — QUANTITIES ARE LIMITED AND SUBJECT TO PRIOR SALE. THIS IS THE ONLY TIME THIS WILL BE RUN, SO SAVE THE AD IF YOU MUST — BUT REMEMBER, TIME IS RUNNING OUT!

QUAN.	DESCRIPTION	PRICE
1	Electrodyne 210L Input Module Line Only — No EQ	\$150.00
1	Electrodyne 310L Input Module MIC/Line — No EQ	
1	Electrodyne 609L Input Module Line Only — W/EQ	
6	Electrodyne 709L Input Module MIC/Line — W/EQ	
4	Electrodyne ACN 2P10 Combining Network 31 inputs with 10 dB gain	
3	Electrodyne ACN 2P20 Combining Network 31 inputs with 20 dB gain	
4	Electrodyne 610 SEQ Input Module, Line Only with EQ and additional Echo Output and Cue Attenuator	\$250.00
18	Electrodyne X4 4 Watt Modular Power Amp OTL	
1	Electrodyne XS1 Special Line Amp	
150	Langevin Attenuators — T, H, Potentiometers, Various Steps and Losses and Some Special Impedances.	

NOW'S YOUR CHANCE TO SAVE ON NEW, DISCONTINUED UNITS. ROTARY AND STRAIGHT LANGEVIN FNT, FNH, FNVU NETWORKS. MOSTLY 600/600. VARIOUS LEGS AND LOSSES.

SAVE!

(WE ARE LOSING ON THESE TOO — YOUR GAIN.)

Call: DON KING • (213) 875-1900

Cetec Audio
A Division of Cetec Corporation

13035 Saticoy Street, North Hollywood, California 91605

Circle 34 on Reader Service Card

JOHN WORAM

The London AES Convention



Our man at the convention was there with camera and notepaper. Herewith is his extensive report.



The Telefunken 24-track tape deck.



This is the Brenell 1-inch deck.



A closeup of the Teknik 1/4-inch unit.

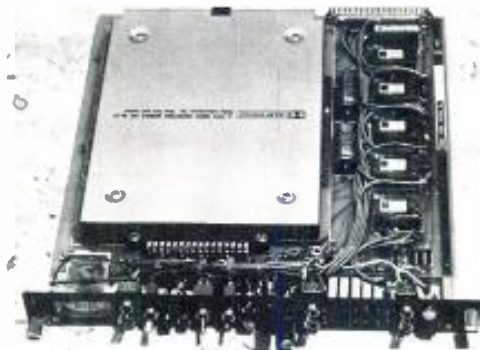

The Cadac noise reduction module.

WELL, we *told* you that you should have come to London with us to attend the 50th (yes, 50th!) Audio Engineering Society Convention. For the benefit of those few thousand who ignored our suggestion, here's a summary of the good time we had.

On Saturday evening—the first of March—a small group of us converged on British Airways at their modern new terminal at Kennedy International Airport. It's an unsettling place to begin a pleasure trip, for it vaguely resembles a deportation center for prisoners-of-war, or perhaps something out of a George Orwell script. The tranquility of the British ticket processing/seat assigning ritual (very, very long) was periodically shattered by an announcement system that the late Cecil B. deMille would have liked. Every now and then, the Voice of God would thunder through the corridors, summoning the masses to their appointed aircraft. I'm sure that anyone who ignored these super-sonic commandments was struck by lightning, but we were an obedient lot, and thus avoided tragedy.

With recollections of the perfection of Copenhagen the year before, we wondered if the A.E.S.'s British Section would be equal to the tasks set before them. Of course we needn't have been concerned; they had done their homework well. A bit *too* well in fact. As an A.E.S. vice president for the eastern region here in the colonies, I'm delighted that it will be up to the western region to put on the next convention. (Los Angeles, May 13-16). I wouldn't want to have to follow the British act.

db May 1975

40

Photos by John Woram and Larry Zide



EMT/Franz showed this sophisticated clock.

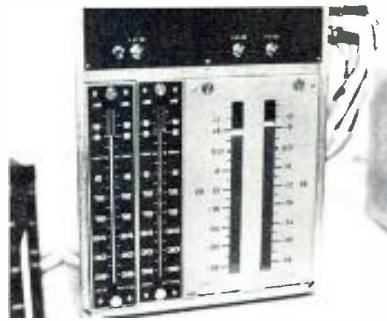

NTP Elektronik makes a range of peak meters.



The MSR/Ortofon disc transfer system.



The Ferrograph Studio 8 in a console.



Keith Monks' Rube Goldbergish record cleaner.

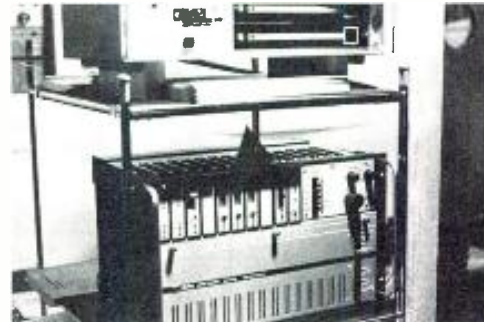

Dolby's film noise reduction equipment.

THE EXHIBITS

Within the exhibit space, were many manufacturers not often seen on these shores. Among them, several interesting tape recorders.

The Teknik ¼-inch machine showed several significant departures from the usual layout. In the photo, note the conveniently large tape timer just below the supply reel. A slide fader, below and to the right of the head stack, varies the fast forward and rewind speeds.

For playback level adjustments, one knob controls the output level for both tracks, while another sets the balance between them, if I read the face plate correctly. Once the balance is set as desired, the single output level knob allows the operator to make overall level changes or fade outs with a minimum of trouble.

Brenell Engineering Co. showed their 2-inch and 1-inch transports—the latter displayed with their electronics package, attached, while the 2-inch deck simply stood alone, ready for mounting in your own cabinet. I imagine these decks are popular in the U.K. with studios on a budget, as they seem to be simply, though sturdily, built. The 2-inch transport specs lists a single speed; 15 in/sec. I discovered the machine did not have motion sensing, when I pushed the wrong combination of buttons (sorry about that, Brenell!). The senior citizens among us may remember when no machines were idiot proof, and the engineer had to have his own brains. Anyway, for lots of money you can now buy machines that will do the thinking for you, while you spend your time on more important things.

But if you have more brains than cash, the Brenell machine deserves a look.

Telefunken's 2-inch, 24-track recorder looks formidable. As you can see, there are lots of knobs to muck about with and—I hope—a protective shield to cover them up while editing.

Ferrograph, probably better known in the U.S. as an audiophile tape deck manufacturer, showed the new Studio 8 machines. These are ¼-inch mono or two track units with motion sensing, tape time readout in l.e.d. units, and a generally fool-proof and solid feel to them. I understand that they will be about \$5,000.00 when they get to these shores, but for that price you also get microphone inputs (balanced).

Cadac had one of their medium-size consoles set up in their booth. They were not at the Copenhagen show, and have not yet exhibited in the U.S., so this was my first chance to see their equipment. The various modules seem to be quite extensive—29 toggle switches on one module alone! That ought to keep any producer busy for hours.

They've also packaged their own noise reduction module, built around a Dolby Cat. 22 card. The module was originally intended for use with Studer multi-track machines having separate sync and playback outputs, both of which may be brought back to the Cadac module. For that matter, I suppose any two outputs could be wired in, at a great saving in time and toil for those studios whose noise reduction facilities must be shared by more than one machine. Alignment controls have a calibrate and a variable position, so that tapes from other studios (you

know, the ones with the wrong Dolby level on them) may be brought into alignment without disturbing your own standard, if you have one.

Next door to Cadac, the series 2000 disc cutting lathe system was shown by *MSR Electronics Ltd.* The system is designed to accommodate the *Ortofon* stereo cutting amplifier and cutterhead. It's risky to jump to any hasty conclusions about anything so involved as a complete tape-to-disc transfer system after staring at it for an hour or so, but it certainly appears well thought out and designed.

Some U.S. engineers already know about the excellent test gear made by *Radford*. They were there with distortion analyzers and audio generators.

Dr. K. Schoeps was on hand at the *Schoeps* booth to show his "Colette Program" of condenser microphones. An interesting feature of the series is a length of cable which may be inserted between the microphone's transducer, or diaphragm capsule, and the amplifier section. The capsule may then be placed up close to an instrument, while the rest of the microphone is well out of the way at the other end of the cable.

The variable pattern capsules in this series continue the Schoeps practice of using a single diaphragm with pattern variations achieved by a mechanical switching system.

Audio & Design Ltd.—not listed in the Exhibition Catalogue—turned up in a corner of the *Trident Audio* booth with a few of their seemingly endless combinations of fascinating signal processing gadgets. They're still not too well known here, which may be a shame, since they appear quite versatile.

Their F769X-R Vocal Stresser combines a parametric equalizer with a compressor/expander on one 19-inch panel. The two may be used in series, separately, or the equalizer may be placed in the compressor's side chain—all at the flick of a three position switch. The compressor/expander and equalizer are both available separately, as well as in two unit configurations.

Ray Cooke's company is *KEF*, a British speaker manufacturer that makes good sounding studio monitors—as well as consumer units. A number of the demo rooms used their monitors.

Last year, *Neve* won the "heaviest in Show" award with their 32 input console that seemed to stretch from one end of Copenhagen to the other. This year it was *Trident's* turn. Their Series A Console—while not quite as long as last year's *Neve* entry—is a formidable mass of knobs, buttons—and switches, which probably needs a co-pilot at both ends.

Meanwhile, down the hall *Neve* showed up with a few smaller consoles, including a 24 in/24 out version for those engineers who have not yet learned how to combine two microphones while recording. Actually, it's a well executed combination of the "we'll fix it in the mix" ap-

proach and the more conventional "get it right the first time" school. Four mixing busses allow combining drum microphones—or whatever—on the session, or quad mix-downs later.

Further down the hall, *Soundcraft Electronics, Ltd.* displayed their compact 16/2 sound mixing console, built into its own aluminum flight case. Just the thing for a band on the run.

At the Dolby booth all their well-known wares were displayed. They are now into Dolbyized movie soundtracks, so they also showed the special noise reduction equipment made to interface with the Academy standard—no mean trick, that.

You can get those discs you neglected really clean with *KMAL's* record cleaning device that shoots liquid onto the disc and then vacuums it off. *KMAL's* amiable Keith Monks was on hand prepared to clean every record in sight.

Of course the quadniks were all there, and as usual have just discovered even more new evidence of the superiority of their various systems. While *JVC* and *CBS* played their latest and greatest quad records, the *Sansui* folks were getting a lot of interest in an old stereo recording of Harry Belafonte at Carnegie Hall. It turns out to be an effective demonstration of the "synthesizer" capability of the latest matrix system. Not to be confused with electronic music, the device responds to out of phase components in any stereo program, and on the Belafonte record, the audience was clearly in the rear speakers while Harry stayed up front.

Of course the convention was not all work and no play (if you can call 4 days of equipment gazing work). The traditional A.E.S. banquet was held in the great hall of London's Guildhall. I'm not sure how convention chairman Ray Cooke pulled that one off, but he did, and did it with style. We were impressively wined and dined and entertained by the orchestra of the Royal Marines School of Music and the New London Singers. There were toasts to the A.E.S., the Queen, and to the President (thank God this didn't happen *last* year), and the presentation of the Society's awards, after which our honored guest, Lord Hill, delivered what was probably the greatest after dinner speech in the Society's history, in which he demolished most of our progress(?) in the communications arts, much to the delight of his audience. I will wisely refrain from attempting to capture his humor here. If you were there, you don't need my comments, and if you weren't, no words here can do him justice.

The following day featured a series of tours to *EMI's* Abbey Road Studios, the *AIR* and *Polydor* Studios, to *Hugh Ford's* testing laboratory, and to several research facilities. Unfortunately, *all* the tours were offered at the same time, so we had to choose carefully. I went to the

Announcing a NEW addition



The STUDIO B



NATURAL ROOM SOUND • INTERNAL/EXTERNAL MIX SELECTION (USE WITH OR WITHOUT A CONSOLE) • REMOTE CONTROL UNIT • PEAK TYPE EQ SELECT PLUS 10 DB VARIABLE EQ GAIN • VARIABLE DECAY • BUILT-IN NATURAL DELAY • BALANCED LINE WITH 5K/600 OHM INPUT SELECT • INPUT SETTABLE FOR NOMINAL ZERO TO +18 DBM • OVERLOAD POINT AT +25 DBM PEAK • 1-3/4" ELECTRONIC RACK PANEL • XLR AUDIO & 'JONES' CONTROL CONNECTORS • VU METER • 115/230 VOLT, 50 60 HZ, 6VA

MICMIX Audio Products, Inc.

9990 Monroe St., Suite 222,
Dallas, Texas 75220

Booth 107 (214) 352-3811

Circle 37 on Reader Service Card

Building Research Establishment to see their anechoic and reverberation chambers. At the time of our visit, they were building a 1/8th scale model of a theatre, in an effort to predict the eventual acoustic properties of the actual full size building. Apparently they play tapes at 8-times normal speed within the model, and make a recording with a suitably placed microphone. When the recording is played back at normal speed, some idea of the acoustical properties of the eventual theater construction may be derived.

In the evening, we visited the Royal Society for a program of papers devoted to the life and work of Alan Blumlein. Although the evening got off to a very slow start with a tedious recitation of Blumlein's personal habits of dress and manners, eventually we were given an interesting description of his important work in audio. It's always unsettling to hear very old stereo recordings that are alarmingly better than most of last week's releases, and it's a shame so many of us knob jockies are not even aware of the possibilities of the Blumlein technique. On the other hand, most producers I know would go into hysterics if they walked into a studio where an engineer was trying out this method of recording.

Speaking of hysterics, the IRA paid its tribute to the A.E.S. by laying a bomb threat on the Cunard International Hotel one morning at about 1:30. To the accompaniment of clanging alarm bells, we were advised by a recorded message, that "an emergency condition within the hotel makes it necessary for all guests to get the hell out before they're blown to smithereens." That's probably not exactly what the announcement said, but in the wee hours of a London night, who takes notes? Anyway, we dutifully left the premises, in various stages of undress, depending on our relative terror thresholds, and stood around in the street trying not to look concerned. To pass the time away, stories circulated about what happens when one sneaks up on a British policeman and whispers "Tic-Toc" in an Irish accent.

At about 2:01, the man from Cunard announced that although the promised detonation had not in fact taken place, it was company policy to ask the guests to remain in the street for a period of one half hour p.b. (post-blast) just to be safe. Well, of course the 30 minutes was over before we knew it—time flies when you're having so much fun—and we were at last welcomed back indoors, where those of us who had rushed out without our keys were quickly let back into our rooms by the staff.

Speaking of keys, the hotel has one of the most unique security systems I've ever come across. People who share a room—even married couples—are permitted only one key, in the best interests of security. When some guests pointed out that both occupants would not necessarily be coming and going together, the desk man suggested that the last one out would leave the key at the desk for the convenience of the first one in.

The beautiful simplicity of this plan was somewhat marred by the fact that the hotel would not only return the key to the first one back in, they would give it to *anyone* who smiled and asked for it. Apparently, Fagin's successors are all well aware of this, for several guests were relieved of their trifles while away from their rooms.

Oh well, this *is* the land of Gilbert and Sullivan, and I guess it's nice to know that their work is being carried on at the Cunard. But I'd watch out for their ships if I were you.

Speaking of which, one of the highlights of the trip was an invitation to spend an afternoon on the Dolby yacht, with Ray and Dagmar Dolby and their new noise production system, Thomas. Actually Thomas was as quiet as his father's earlier inventions (well, almost) and we all had a delightful time. If the I.R.S. is reading this, we discussed only business. ■

PROKIT

THE FLEXIBLE MIXER SYSTEM with RAVE REVIEWS!

LARRY ZIDE in

db

THE SOUND ENGINEERING MAGAZINE

"No kit I have ever built has had the quality of componentry that exists in this unit . . . This unit is fully professional in every way — nothing about it is consumer . . . Well worth the asking price of \$299.00 kit."

ED DELL in

the Audio
Amateur

" . . . one of the finest pieces of audio equipment available to the home user . . . In use, the SM-6A is the equal of any piece of audio equipment it has ever been our pleasure to use. Intermodulation distortion (60 & 6,000 Hz, 4:1) on the microphone inputs was 0.008% @ 0.6V out. In use the SM-6A is a solid, smooth, well built unit."

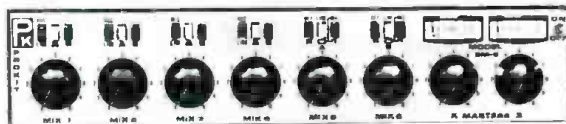

SM-6A
MIXER

\$369 KIT \$599 WIRED

• 6 mic, 6 line, and 2 mag. phono inputs • low noise IC circuitry • VU meters



EQ-6
EQUALIZER

\$159 KIT \$299 WIRED

• individual high and low frequency equalization for each SM-6 input



EK-6
REVERB UNIT

\$195 KIT \$354 WIRED

• 6 individual send controls • 2 quality reverb springs
• each input assignable to either or both outputs



GATELY ELECTRONICS, Inc.

57 West Hillcrest Ave.
Havertown, Penna. 19083
215-449-6400

How to Make a Simple High-Speed Tape Duplicator

Ingenious modification of inexpensive used recorder and playback machines produces a high-quality duplicator.

THERE HAVE BEEN numerous times when I have wanted to make a fast, high-quality tape copy without taking all the time necessary to run one or more off at a one-to-one speed. This little setup will save you almost fifty percent of time making copies, running as it does at about 13 in./sec. (We'll tell you why we arrived at that speed later.) The extra speed is gained with absolutely no sacrifice of quality. Yet, you can make this little high-speed combination, using only your own ingenuity and skill, at a fraction of the price of professional equipment.

EQUIPMENT FOR MODIFICATION

The first thing to do is to locate suitable equipment for modification, such as the Ampex 960, produced in 1958 and 1959. Or, you can use the older A122 or the later 1200 and F series. Although the A122 played two-track stereo, it recorded only one-half-track monophonic. Many of these have been modified by exchanging the original reproduce head with the later head, which can be shifted manually to reproduce either 2-track or 4-track stereo, just like the 960. So, as a playback machine, an old A122 would be suitable for our high-speed duplicator.

Then there was the 970, identical to the 960, except that the case was larger in order to accommodate two small power amplifiers and two speakers. When a 960 has no case, it is then known as a 950, perfectly acceptable for our application, as is the 970. Or a 1270, which is a 970 with a 1200 series tape deck.

The 1200 series—more particularly the 1260—is very like the 960, except that it is totally committed to the 4-track configuration. It is suitable for our purpose as a reproduce machine if only 4-track tapes are to be copied; or as a recording machine if only 4-track copies are to be made. The electronic modification would differ slightly from that described in this article, so, in a sense, you

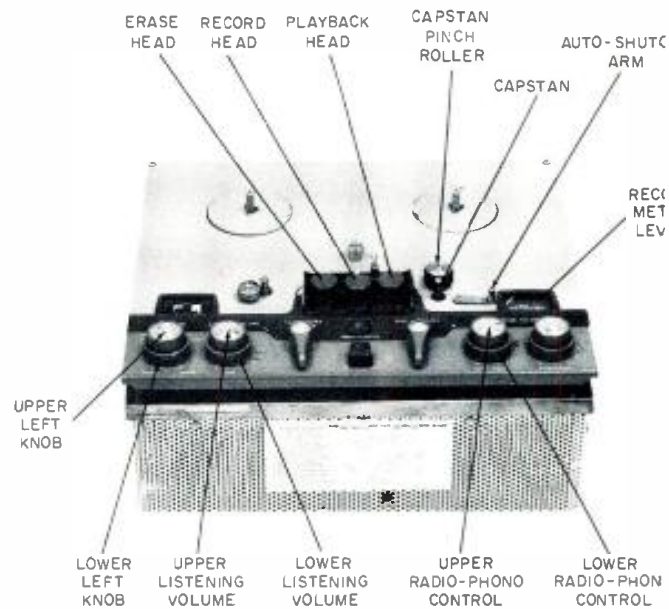

Figure 1. Adjusting listening volume control.

would be on your own. The same applies to the F series, but they, too, can be made suitable. With a little ingenuity you can make any of these models I have mentioned serve in the reproduce or recording functions, and in some cases, either.

Since the playback equalization of the reproduce machine is not altered, it may be feasible to think of using any good-quality machine you may have at present for the reproduce function. In all likelihood its capstan will not have the same diameter as that of the 960, or the other Ampex machines mentioned. If such is the case, you might be able to measure carefully its capstan diameter and have a special sleeve made up for it which has an inside diameter equal to your capstan diameter, and an outside diameter of 1.76 times your capstan diameter. You

Bob S. White has been involved in the reproduction of sound since the 1930s. He is with the Ampex Corp. in California and is an active amateur radio operator.

HEAD FACES APPEAR SIMILAR TO THIS SKETCH AREA TO APPLY SILVER PAINT, IF NECESSARY, IS INDICATED BY HEAVY DOTTED LINE

AT ALL COSTS, AVOID GETTING PAINT ON GAP, WHICH IS REPRESENTED BY THIN VERTICAL LINE DOWN THE MIDDLE

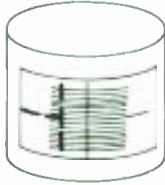

Figure 2. Head face showing area to which to apply silver paint. Avoid getting paint on the gap, shown by thin vertical line down the middle.

may also have to contend with other attendant mechanical modifications, but they may be worthwhile because you would then have to find only one Ampex machine.

So where to find these machines? If you can't find one in a store try an ad of your own, or any other suitable method of making contact with owners of these now-ancient, but perfectly useful, quality machines. I have seen them sell for as little as \$75, even in good shape. You might have to pay a little more, but not much. Whatever you find, this article deals primarily with the 960, but it will give you some ideas that you might use on other machines, too.

It is not too commonly recognized that the electronic circuitry—and even the heads—of these Ampex machines are quite closely patterned after the big, professional 351-2, costing three or four times the original price of the 960, which sold for about \$700. Therefore, you might classify it as a semi-professional recorder though it was produced with the home market in mind, and lacks some refinements of the big machine. With a little time and effort it can be brought up to full professional specifications except in one point, and that is constancy of tape speed.

In professional machines you are aware that the capstan is driven to power-line frequency; in the 960 the capstan is driven by a good-sized induction motor, the speed of which is slightly dependent on power-line voltage. Power-line voltage fluctuations produce small tape-speed fluctuations, usually insignificant for most applications. From time to time there might be an almost imperceptible change in pitch depending on line voltage value at the time. As for flutter and wow, there is no problem at all in making a 960 meet the same specifications as its big, professional brother, or better.

EXAMINING A USED MACHINE

Now let us assume you have located a machine which might be suitable. Before you commit yourself, what should you look for in the way of possibly serious defects? If everything runs and plays, your examination can be confined to the head assembly. Remove the plastic cover with the name Ampex on it; then remove the mumetal head cover under that. Check the heads for wear, because if they are badly worn you may soon be in for expensive replacements. Expect to find some wear—and some can be tolerated, but not too much.

With your fingernail, feel for the "lip" at the upper and lower extremities of the tape passage across each of the three heads. Any more than about three-thousandths wear would be too much. If the heads pass this test, take a wooden match stick, or something similar—not metal—and gently try to move the inner section of the head—the part the tape contacts—from side to side. With age and

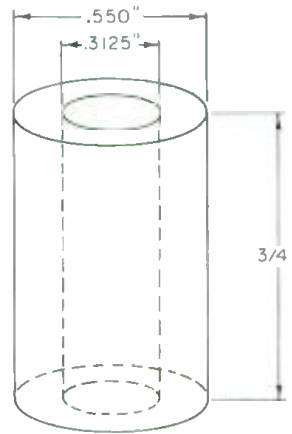

Figure 3. Capstan sleeves to be fabricated, one for each machine.

heat, the bonding material which holds the head itself to its individual mumetal shield and triangular baseplate sometimes deteriorates to the point where the head "floats" inside its shield. If any of the three heads show this problem, you are going to be in for some extra work, and the price should be adjusted accordingly.

What you will have to do then is to dismount the whole head assembly by removing a screw, the playback head guide-pin (which is also a screw with a funny slotted head), and the playback head mounting arrangement which permits that head to slide manually up and down on a post to accommodate the playing of either 2-track or 4-track tapes. There is a little Philips-head screw on top of the post. Loosen this screw with a suitable screwdriver. Generally as you turn this screw the whole post will turn and come up and out along with the playback head. *This is what you want.* If the screw comes out by itself, you will have to resort to other means to remove the post. The best way I have found it to insert the *back* of a needle file into the screw-hole on top, and gently turn the post out, perhaps with the help of a pair of pliers on the file. If this is done *gently*, the threads in the hole should not be damaged. When the post, guide-screw, and the other screw are all removed, the entire head assembly can be lifted up. It is generally not necessary to disconnect any of the heads, but this may be done at your discretion.

Then you must remove from the affected head (or heads) the three screws and springs which hold the head's triangular base-plate to the main head-box, or, in the case of the playback head, to the lower base-plate. It isn't all that complicated, so don't let it frighten you, but be sure not to lose any of the little hardware. Notice, too, that the springs under the playback head are different than the others, so that you will be reminded to put everything back together the way it all came apart. And when you have done all that, then the head, its shield, and its triangular base-plate can all be re-secured from underneath with epoxy, and left to set. Five-minute epoxy works very well if you can work fast. Make sure everything is well pushed together until set. Be very careful not to get the slightest hit of epoxy on the face of the head.

CHECK FOR GROUNDING

When the epoxy has set, you will have to check with an ohmmeter to see if the head laminations, shield and base-plate are electrically grounded to each other. They probably won't be. In that case, get a small bottle of conductive silver paint such as GC 21-1 at your local electronics supplier. After cleaning the necessary areas with

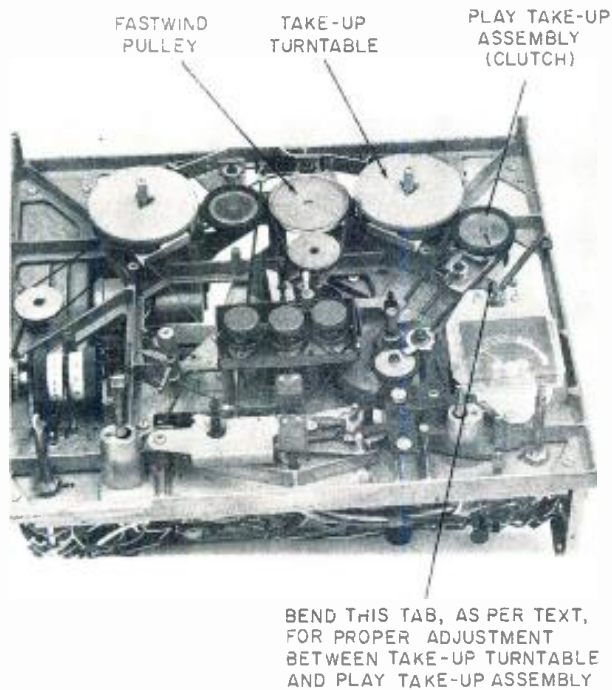

Figure 4. Top view with cover-plate off.

alcohol on a swab, apply a thin bead of silver down the very edge of the head laminations, in front (see FIGURE 2). Then bring some over to connect to the head's mu-metal shield—the one surrounding the head. Whatever you do, make sure the silver is carefully applied only to the edge of the head laminations, sparingly, and not anywhere near the almost-invisible gap at the center of the head. Then apply some silver externally between the triangular base-plate and the mu-metal shield so that when the silver paint dries everything will have a common electrical bond. Otherwise, you may get hums and crackles. And incidentally, do not expect to find the paint conductive until after the solvents have evaporated. This may take a half hour or so.

After the paint dries, put the assembly back together in the machine, and align the individual heads so that they stand up straight. Use the capstan as a guide, and adjust the heads so they do not lean backwards or forwards. You do this by sighting the playback head (the one on the right) along the capstan, then sight the other heads along each other. Do this carefully—it isn't hard.

You probably won't have to do any of the above, as the heads likely will be okay. But I'm telling you what to do if it has to be done.

Next, put a running tape on the machine and align the heads vertically so that the same amount of head lamination material shows up above and below the tape as it travels across the heads. With the tape in motion, it is easier to see what is taking place. To raise or lower the head for this adjustment, turn *all three* head-mounting screws on the corners of the triangular base-plates the *same amount* in the appropriate direction, so you won't disturb the previous back-and-forth adjustment.

Inasmuch as the playback head is of the type that is manually shifted up and down a small amount by the little shift lever, you must give it a special adjustment at this time. Looking at the face of the head you will see two different metals—the top metal is brassy looking, and just below it there is shiny metal, like polished steel. With the head lever in the UP position (and it doesn't move very far, remember) the very upper edge of the tape must just pass along the division between the two kinds of

metals. This is critical, but not complicated. You will make one final adjustment to each of the heads later.

CAPSTAN SLEEVE

Now the major mechanical modification of the equipment involves the fabrication of a capstan sleeve for each machine (see FIGURE 3). These can be made of steel or brass. Brass is easier to work, but I prefer steel, since it is less subject to damage or deformation when being put on or taken off the capstan. Too, its coefficient of expansion will be the same as the capstan, and this helps. Steel will wear longer, too. But make sure you properly demagnetize the capstan sleeves before using them, or you may spoil not only the tape copy but also the original tape recording! Now is a good time to demagnetize the record and playback heads as well. The erase head is self-demagnetizing.

In order to make your machines run at high speed, it will be necessary to have one capstan sleeve per machine made up in a machine shop if you cannot make them yourself. A word of warning: The success or failure of the project depends a great deal on the accuracy of these sleeves. While simply constructed, they are not simple to construct. It does take workmanship, and except for length, tolerances must be held to one ten-thousandth of an inch for best results.

The capstan of the 960 and related machines is .3125 in. in diameter; therefore, the inside diameter of the sleeve must be such that it will slip on smoothly but with no apparent extra clearance. One end should be slightly tapered inside so that a light tap with a plastic handle of some sort will secure the sleeve to the capstan, yet will allow it to be removed by a slight upward pressure from a screwdriver blade. Mark the top of the sleeve with a felt pen so *up* can easily be identified. The outside diameter also must be held to close tolerances for correct tape speed and low flutter and wow. Do not tolerate any compromise in these important dimensions.

The outer diameter of the fabricated capstan sleeve is .550 in., which produces a tape speed of 12.88 in./sec. as related to 7½ in./sec. without the sleeve. To all intents and purposes, you might consider the tape speed as 13 in./sec. This was arrived at by considering the maximum tape take-up ability of the recorder onto an empty reel with a 2-in. diameter hub. Also the resting space between the capstan pinch roller and the capstan must be considered; a sleeve with a larger diameter would impose very unusual stresses on the pinch roller spring, and also on both the capstan and pinch roller bearings. So about 13 in./sec. is considered to be maximum.

This speed does pose a little problem if you want to use take-up reels with a smaller hub, such as a standard 5-in. reel which has a 1¼-in. hub, because the reel is initially unable to accept the tape as fast as the capstan feeds it. But there are two ways around this little dilemma, both producing essentially the same results. One is to secure the automatic shut-off arm to the top-plate in the *up* position with adhesive tape; the other is just to bypass the shut-off arm altogether. I prefer the former. Then the tape on the 5-in. reel will be slack for a minute or so, but will eventually tighten up. If you do not follow one of these suggestions with a small hub, the automatic shut-off will trip and shut you down. With a 2-in. hub or larger, there is no such problem.

INTO THE ELECTRONICS

While the capstan sleeves are in the making, you can ready the electronics. But before that, remove the top cover-plate from the machine (it takes a small size *spline* wrench to remove the speed change knob, which is available at most hardwares), and examine for mechanical malfunctions. You might want to replace the belts, which are

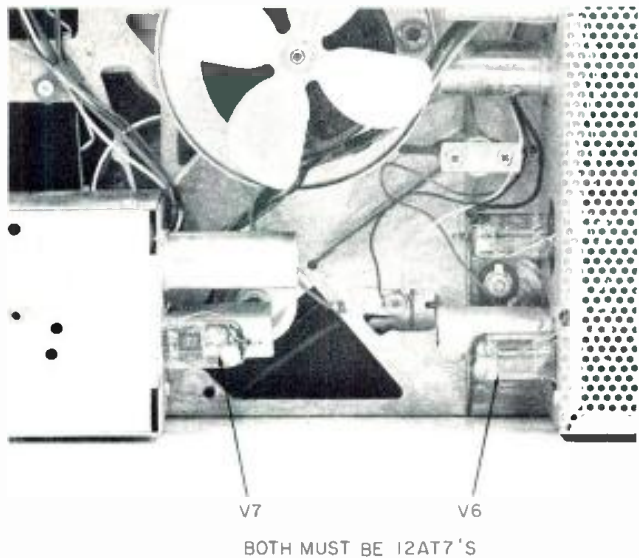

Figure 5. Bottom view.

available from your electronics dealer. Walsco makes them. There are several areas you should check. Make certain the speed changes smoothly. Freedom from oil contamination helps here. The play-takeup assembly (the clutch—see FIGURE 4) is prone to problems, so make sure it “clutches” internally, and *not* between its rubber rim and the take-up turntable on which the reel rests. Do not tolerate the latter. The fastwind pulley, driven through the shortest belt from the motor, is inclined to seizure. It might be wise to remove the assembly, take off the pulley, polish its shaft with “crocus cloth” if it is blue, clean, and lube it.

Outside of the addition of the capstan sleeve, there is only one mechanical modification. Sticking straight up from the play-takeup assembly is a tab which has the control rod through it. Replace the capstan pinch roller, install the fabricated sleeve, then take this tape and bend it *towards* the capstan so that the rubber rim of the play-takeup assembly wheel contacts the take-up turntable *just before* the capstan pinch roller makes contact with the capstan sleeve. Make the bend a little at a time until it is just right. Unless this bend is made just right, the capstan-pinch roller combination will start feeding tape before the take-up mechanism is ready to accept it. That would result in an aborted start, as the automatic shut-off will go into operation when the resulting tape loop forms.

MODIFICATION AND ADJUSTMENTS

For the electronic modifications and adjustments, a service manual, or even a schematic, will be of considerable help. Try Sams 452-5.

There are two electronic modifications to make to each channel, and one to check to see if it has already been made. Locate the tubes which drive each record head channel (FIGURE 5). If you managed to find a manual, they will show as V6 and V7. One is on the main chassis, and one is on the little corner chassis. These tubes should be checked for number. Originally they were 12AU7s. The 12AT7s were later installed at the factory for improved performance. Replace these if necessary. No component changes are necessary. It would be a good idea to test *all* the tubes.

From pin 3 of each of these 12AT7s you will see a capacitor (usually .015 mFd., though I have seen other values) which connects to a 7.5 mH inductance. Change

these to .0033 mFd. This alters the record equalization to suit our purpose and is critical. Then we must derive the record head bias in a different manner than originally. Referring to FIGURE 6, we take the wire which comes from C20 to C21 and move the end over to the other side of C21 so the bias is derived directly from the oscillator transformer. That takes care of the left channel and only takes a moment.

Electrically, we do exactly the same thing for the right channel, but physically it isn't quite so simple. You will find C28 and C29 in close proximity to C20 and C21, but there is a slight problem in that C29 is connected directly to a lug on C28, so there is no simple wire to switch over. The best way I have found is to switch ends on C29 in the following manner: Remove the yellow erase head lead from the junction of C28 and C29, and connect it to the other end of C29. Remove the green wire at that point which comes from the switch wafer and connect it to the junction of C28-C29. The wire will not be long enough, so must be replaced with something longer. This hook-up is standard on the 1200 Series.

ALIGNMENT COMES NEXT

Believe it or not, that completes the modifications. Now comes the alignment. Put your machine all back together except for the two head-box covers. We still have to get at the heads. You had better leave off the electronics cover with all the little holes, too. Then it will be easier to get at the adjustments. Don't overlook the cleaning and demagnetizing of the heads.

We will assume you have access to an a.c. meter of some kind capable of reading from 0.2 to 1 volt at 15 kHz. You will also need an audio generator reasonably flat from 50 Hz to 15 kHz. Then you should have a full

Westlake Audio V.S.O.

The Westlake Audio V.S.O. offers a system which combines a solid state power amplifier, variable frequency oscillator and digital read out in one compact 19" rack mount package. Available with optional machine selector panel. Available thru Westlake Audio Special introductory offer for a limited time only \$495.00. Ask about our offer on the remarkable Wattnott Product Generator.

from acoustic design to down beat...

Westlake Audio

6311 Wilshire Blvd
Los Angeles, California 90048
(213) 655-0303

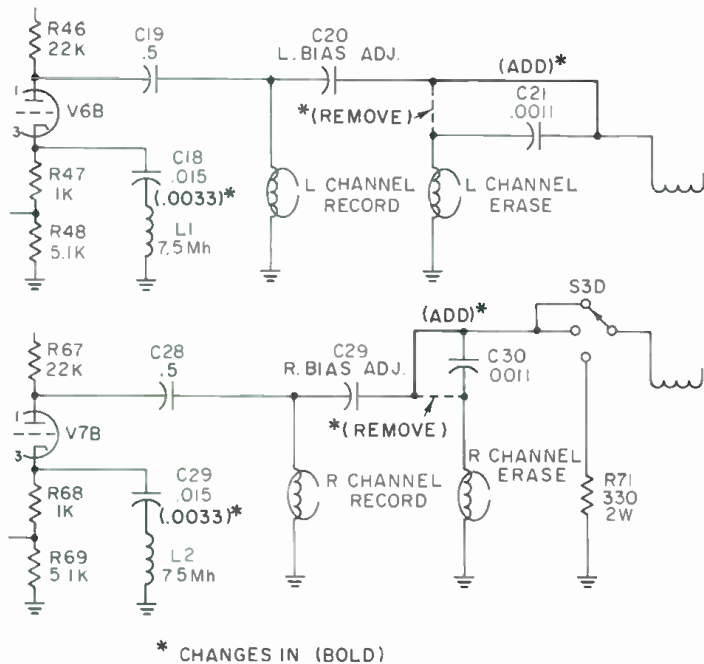

Figure 6. Take the wire which comes from C20 to C21 and move the end over to the other side of C21 so the bias is derived from the oscillator transformer.

track-alignment tape such as Ampex 31321-01 or equivalent, with tones from about 50 Hz to 15 kHz at 10 dB below operating level. This is mainly for playback head azimuth adjustment. If you do not own one, get one. If you just can't locate one, there is a reasonable way around it. I'll tell you what to do later.

If you have the alignment tape, connect your a.c. meter to the RIGHT channel output jack on the back of the recorder. The reason for this is that at that jack you have access to the signal from either right or left playback channel simply by flipping the upper left hand knob from STEREO (right channel) to SINGLE (left channel). (See FIGURE 1.) This saves all the mess of plugging and unplugging the a.c. meter when changing channels. Then connect the LEFT output jack to a suitable amplifier so you can hear what is going on on the alignment tape.

Now, with the fabricated capstan sleeve off, speed at 7½ in./sec. and the upper left hand knob on STEREO, when the 700-Hz tone comes on, quickly adjust the lower LISTENING VOLUME control to read 0.2 volts, or -12 dBm if your meter has a dB scale. While the 700-Hz tone is still playing, change that upper left hand selector knob to SINGLE, and while holding the lower LISTENING VOLUME control in its previously established position, turn the upper LISTENING VOLUME control to also read 0.2 volts on the a.c. meter. Mark the position of these two LISTENING VOLUME settings, and do not change them for the remainder of the alignment. They should be at approximately 8 on the numbered scale around them.

FINAL ADJUSTMENTS

When the 15 kHz tone comes on, we have come to the time to adjust the playback head azimuth. Simply go to the little screw on the right side of the playback head triangular base-plate, and carefully adjust it for maximum output on the a.c. meter. It should come up to around 0.2 volts. If it does not, double check your azimuth adjustment; make sure your playback head shift is in the lower of the two positions. If that doesn't do it, re-clean the head with a reliable head cleaner. In an emergency,

use denatured alcohol. Never use isopropyl. For some reason I have had bad luck with it. It seems to glaze over the face of the head and make things worse than ever. I suspect it dissolves the head lamination binder.

As a last resort, break a woden Q-tip in half, and rather vigorously scrub the playback head gap with the bare wood. Never use anything metal for this! You should be able to bring up that 15 kHz signal to around 0.2 volts on each channel. If it still doesn't come up, check to see if you have the "gismos" mentioned two paragraphs ahead.

So what do you do if you just couldn't come up with a suitable alignment tape? Well, set both LISTENING VOLUME knobs to 8, and take it for granted your listening levels are pretty close. Then put a tape on which has a superabundance of highs, such as bells, cymbals, or glockenspiel, or something like that. Fully turn up the treble response on your listening amplifier which you have connected to the 960, then adjust that playback azimuth screw back and forth until you locate the point of maximum brilliance of sound. While you have to rely on your ear for this, it should come out pretty close.

This completes the playback adjustments, with one possible exception. Look inside the electronics and see if your machine is equipped with adjustable playback head-swamping resistors. Some units came out with these, and they can give trouble if misadjusted. If yours has them, you will find them right where the playback head leads connect to tie-points in the electronics. They will be one unit: a white ceramic section with two blue adjustments, 1¼ in long and ¾ in. wide. I generally remove the whole thing. It is there to dampen the high frequency response of unusually "hot" heads. By now your playback head likely doesn't need it! Finally, check the erase-head azimuth. It is not critical, and may be adjusted by sight.

RECORD CIRCUITRY AND HEAD

Now we will undertake to align the record circuitry and head. Get yourself a good quality tape of the type you will generally be using. Put it on the machine in the record mode, at 7½ in./sec., with the audio generator connected to both radio-phono inputs and a frequency of 500 Hz, with both the upper and lower radio-phono controls set to around 8—with both microphone gains set at zero. Adjust the output of the audio generator until the record level meter on the machine comes up to about the N in the word "normal." Adjust the relative settings of the two radio-phono controls until the meter reads the same for each channel. Remember that the LISTENING VOLUME controls must still be at their previously established settings.

With the audio generator at 3000 Hz, and the same output as above, adjust the left (C20) and then the right (C29) channel bias for maximum output on your a.c. meter (see FIGURE 7). Perform this operation with care, it is vitally important. You will have to change C20 and C29 quite a bit because we have modified that circuitry. By making our bias adjustments at 3,000 Hz we slightly underbias the machine a predetermined amount at the lower frequencies, but this slightly improves the high frequency response in the record mode. Then with your audio generator at 15 kHz, adjust the record-head azimuth screw for maximum output on your a.c. meter. The record head is the middle one, and its azimuth adjustment screw is the one on the right corner of its triangular base-plate.

At this point, you might want to check the overall frequency response of your machine. With this modification it will be normal to have the frequency response gradually taper off somewhere above 4,000 Hz. You might want to devise some way of switching the values of the two capacitors you changed from 0.015 to 0.0033 back and forth so

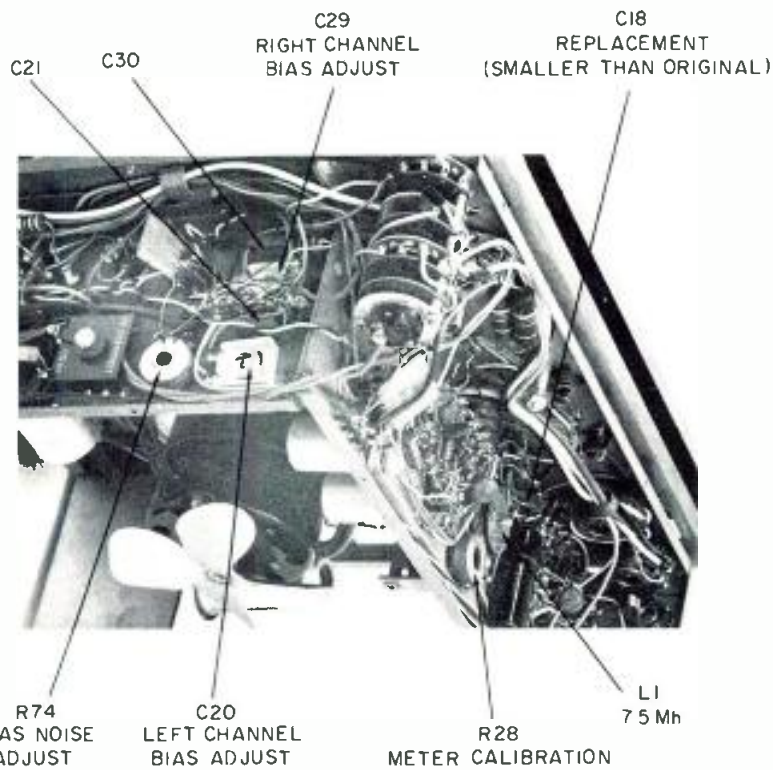

Figure 7. View of electronics.

Deviation in dB From Ampex Standard Alignment Tape

Freq.	31311-01 15 i.p.s.	31321-01 7½ i.p.s.	31331-01 3¾ i.p.s.
15 kHz	-1	-1	
12 kHz	-1	0	
10 kHz	-1	-½	
7.5 kHz	0	-½	-1½
5 kHz	0	+1	-1
2.5 kHz	0	0	-1
1 kHz	-½	0	0
500 Hz	+1½	0	0
250 Hz	+3	+1	0
100 Hz	+3	+1	+1
50 Hz	+2	+2	+1½

To derive these figures each alignment tape was copied at 13 i.p.s. and then compared with the alignment tape itself.

signals in play mode. That will take a little longer.

Now go to the nine little head-mounting screws (three per head), and put a little touch of radio cement on each so that the cement is in contact with both the screw head and the triangular base-plate. That will lock the screws against possible vibration or shock.

REPRODUCE MACHINE

This completes the modification and adjustment of one machine of your high-speed duplicator system. Only the machine on which you plan on *recording* the copy has to be electronically modified, if the reproduce machine is in normal condition. However, I would at least want to go through the playback checking and adjustment routine described here to make sure the reproduce machine is satisfactory. It is a very vital link in the chain. You will have to make the mechanical modifications, nevertheless, and assure yourself of its mechanical integrity. But we think you will want to modify both machines if the second one is a stereo machine and therefore suitable for either reproduce or record function. You will be surprised at how much faster the second one can be done.

Now that the modifications are complete, you will want to try out your device. This combination should produce superior copies of 7½-in./sec. masters, as you will notice from the frequency chart at that speed. The chart shows that there is the slightest bass boost, which may almost be beneficial. 7½-in./sec. masters also come out very well when reduced to 3¾-in./sec. copies. Excellent 3¾-in./sec. copies can be made from 3¾-in./sec. masters, with only the slightest loss of high frequencies, not detectable to my ear. We also have reason to believe that a 3¾-in./sec. master will produce an acceptable 1⅞-in./sec. copy, but we had no way of proving it, since we have no 1⅞-in./sec. playback capability.

The comparisons in the chart were arrived at by duplicating the appropriate Ampex alignment tape, then comparing the copy with the original.

If you have a need for the capability of making high quality copies at reasonably fast speed and are interested in an absorbing, educational, inexpensive and rewarding project that is well within the capabilities of anyone who has a minimum of test equipment and know-how, the foregoing procedures should help you. For the serious recordist, this is no toy, but a worthwhile adjunct to your equipment, and something you will be using for years. You can add as many machines to the system as your need requires, within reason. You might have to figure out a way of starting them all at once if the number gets too big. But the end product is well worth the effort. ■

that you can select the appropriate value, for duplicating, or for regular use. This would be the time to decide.

When checking the overall frequency response, make sure the record meter level on the machine is not reading more than the N in the word "normal;" otherwise your high frequency readings may be inaccurate due to possible tape saturation.

NOISE CONTROL

With the machine still in the record mode at 7½ in./sec., and *no* signal input, adjust the noise control R74 (FIGURE 7) for a minimum of popping as heard through your amplifier. This adjusts the bias signal for best linearity which produces minimum popping over slight irregularities of tape oxide.

Then, still without changing the LISTENING VOLUME control settings, inject enough signal at 500 Hz from the audio generator to read 0.62 volts, or -2 dBm on the a.c. meter. This is normal operating level, and the record level meter should read on the line between "normal" and "high." If it does not, adjust the meter calibration pot, R28 (FIGURE 7) until it does. There is only one such adjustment for both channels, so when you switch the record meter to the other channel by changing the *lower* left control knob (FIGURE 1) from L to R (or vice versa), there should be very little difference in the reading. If there is much discrepancy it generally means the bias adjustments have not been properly made; we suggest you go over them again if such is the case.

The record bias frequency in the Ampex 960 is approximately 100 kHz, and is not critical. But if you don't have a suitable filter between the recorder and your a.c. output meter—and you likely won't have—some bias will likely get into your output meter in record mode. If it does, it generally will be at a level below your wanted signals, so that you can still get the information you want from the output meter. If the bias signal coming through is *greater* than your wanted signals, it will mask the information you want to get at. I just mention it as a possibility, but it is unlikely. But if it does happen, you will have to record your signals, then rewind the tape and read your

db classified

Closing date is the fifteenth of the second month preceding the date of issue.

Send copy to: Classified Ad Dept.

dh THE SOUND ENGINEERING MAGAZINE

1120 Old Counry Road, Plainview, New York 11803

Rates are 50¢ a word for commercial advertisements.

Employment offered or wanted ads are accepted at 25¢ per word.

Frequency discounts: 3 times, 10%; 6 times, 20%; 12 times, 33%.

FOR SALE

BROADCAST AND RECORDING EQUIPMENT: Scully; Metrotech; Langevine; Electrodyne; Q.R.K.; Micro-Trak; M.R.L.; Nortronic; McMartin; U.R.E.I.; Revox; Crown; Byer; Lamb; Master Room; Stellavox; E.V.; A.K.G.; Sennheiser; Atlas; Ferrograph; HAECO; Stevenson; Gately; dbx; Advent; Altec; Fairchild; Audio Designs; 3M; Magnacord; Telex; Inovonics. Disc recording systems; package deals; installations; service. **Wiegand Audio, Middleburg, Pennsylvania 17842. (717) 837-1444.**

ORTOFON

DYNAMIC MOTIONAL FEEDBACK mono disc cutting system. Complete amplifier system: drive, feedback, and feedback-playback monitor preamp; rebuilt, original factory parts. Guaranteed. **Albert B. Grundy, 64 University Place, New York, N.Y. 10003. (212) 929-8364.**

MONITOR EQUALIZERS for your Altecs & J.B.L.s are a steal at \$75/channel

+

FREE ROOM EQUALIZATION with purchase of 1/3 octave filters. This is not a misprint. **Music & Sound, Ltd., 11 1/2 Old York Rd., Willow Grove, Pa. 19090. (215) 659-9251.**

→ S.M.E. Damping Mods—\$30.00 ←

SCULLY, ELECTRO-VOICE, Neumann, Shure, Spectrasonics, Quad Eight, Masterroom, ARP, Corwn, Microtak, Russco, dbx, Interface, EMT, and others. **The Audio Marketplace, Div. United Audio Recording, 5310 Jackwood, San Antonio, Texas 78238. (512) 684-4000.**

DISCOTHEQUE MIXERS from \$325.00; equalizer speakers with built-in power amplifiers; bi-amped systems and complete portable discotheque systems. Write us for literature. Dealer inquiries invited. **GLI, Box 2076, Dept. D, Brooklyn, N.Y. 11202. (212) 875-6992.**

AUTOMATED QUAD PANNING

THE UNIQUE AQC SYSTEM (PAT. APPLIED FOR)
CAN DO WHAT HANDS CANNOT

4, 8, 16 & 24 INPUTS

VIDEO & AUDIO ARTISTRY CORP.

p.o. box 4571, boulder, colorado 80302

(303) 499-2001

LOWEST PRICES IN THE COUNTRY on microphones, power amps, speakers, musical instruments, P.A. equipment, including Peavey, Heil, J.B.L.; huge stock, top brands only. **Gracin's 110, 606 Rte. 110, Huntington, N.Y. 11746. (516) 549-5155.**

WHATEVER YOUR EQUIPMENT NEEDS—new or used—check us first. We specialize in broadcast equipment. Send \$1.00 for our complete listings. **Broadcast Equipment & Supply Co., Box 3141, Bristol, Tenn. 37620.**

THE LIBRARY . . . Sound effects recorded in STEREO using Dolby™ throughout. Over 350 effects on ten discs, \$150.00. Write, **The Library, P.O. Box 18145, Denver, Colorado 80218.**

TASCAM REVERBS—\$500; Tascam mixing consoles—\$2,350; Tascam 1/2-inch recorders—\$2,750; Tascam 8-track recorders—\$4,600. All shipped prepaid/insured, including free alignment/equalization/bias/calibration. **Music & Sound, Ltd., 11 1/2 Old York Rd., Willow Grove, Pa. 19090. (215) 659-9251.**

AMPEX, SCULLY, TASCAM, all major professional audio lines. Top dollar trade-ins. 15 minutes George Washington Bridge. **PROFESSIONAL AUDIO VIDEO CORPORATION, 342 Main St., Paterson, N.J. 07505. (201) 523-3333.**

ONE WAY NOISE REDUCTION for cutting rooms/tape copies; retains highs, rids hiss/surface noise & clicks/pops by a full 10-14 dB and costs \$150 up per channel! **Music & Sound, Ltd., 11 1/2 Old York Rd., Willow Grove, Pa. 19090. (215) 659-9251.**

CROWN D1200, M600, and M2000; drives RTR "Monitor" speakers, on demo now in our showroom. **Barclay Recording, 503 Haverford Ave., Narberth, Pa. (215) 667-3048.**

NEW MODELS: Ampex AG440C 2-track, servo capstan motor; Scully 280B; used AG440Bs; used Scully 280, 8-track, new heads, in console, excellent condition; Sennheiser mics. Immediate delivery from stock. **Malaco Recording, Jackson, Miss. (601) 982-4522.**

MULTI-TRACK

- ★ SERIES "B" MIXING CONSOLE
- ★ VARI-BAND 5 SECTION PARAMETRIC EQUALIZER
- ★ DUAL EQUALIZED REVERB
- ★ LONG & SHORT THROW SLIDE FADERS
- ★ HIGH BALLISTIC VU METER

P.O. BOX 3187
HOLLYWOOD, CA 90028
(213) 467-7890

AMPEX 300, 352, 400, 450 USERS—for greater S/N ratio, replace first playback stage 12SJ7 with our plug-in transistor preamp. For specifications write **VIF International, Box 1555, Mountain View, Ca., 94042. (408) 739-9740.**

NEUMANN LATHE, rebuilt, Lyrec motor, Scully saddle with EICO L.P.I., \$5,000.00. Write: **A. Angileri, 6331 S.W. 80th St., S. Miami, Florida 33143. Phone: (305) 667-4148.**

\$1 MILLION USED RECORDING—PA—BROADCASTING EQUIPMENT. Send \$1.00 for list, refundable, to **The Equipment Locator, P.O. Box 99569, San Francisco, Ca. 94109.**

COHERENT CONCERT SOUND—more than P.A.! We work with musicians to create an aural environment in concert that matches studio production. (212) 947-1271.

FOR SALE: 20 Gotham 600-ohm sliders, \$20.00 ea.; Simpson 1 1/2-inch vu meters, \$12.00; passive hi-lo equalizers, \$10.00; assorted rotary attenuators, \$5.00. (212) 581-0123.

TUNED ROCK P.A.s Customized high intensity touring/permanent installation sound systems, including narrow band (5 Hz!) feedback suppression, detailed regenerative response Acousta-Voicing/environmental equalization (± 1 dB at your ears), room design/measurement/treatment, $\leq 15\%$ articulation loss of consonants; 1000s of customized professional products, including fiberglass horns, consoles, comp/rms/peak limiters, 18 dB continuously variable electronic crossovers, digital/acoustic delays, omnipressors, phasors, reverb, echo, doubling/tripling effects, P.A. noise reduction; piezo transducers; frequency shifters from: J.B.L./Altec pro, Tascam, U.R.E.I., Eventide, Gately, Schoeps, Beyer, Crown, Community Light/Sound, Mom's Audio, McIntosh, Bozak, Allen & Heath, etc. etc. All shipped prepaid/insured. **Music & Sound, Ltd., 11 1/2 Old York Rd., Willow Grove, Pa. 19090. (215) 659-9251.**

Inventors/Engineers

**ONE STOP
FOR ALL YOUR PROFESSIONAL
AUDIO REQUIREMENTS
BOTTOM LINE ORIENTED
F. T. C. BREWER CO.
P.O. Box 8057, Pensacola, Fla. 32505**

BABY BOOM STANDS and a snake, 100' or >, 15 pair or >. **Ray Eldred, 2703 W. 9th, Olympia, Wash. (206) 357-6885.**

SOUND SYSTEMS FOR SALE; full rig Rolling Stones quad concert sound systems; like-new Crown DC-300A & DC-150 power amps; nine frequency band mixing consoles; J.B.L. 2220B & 2130 base speakers; 2440 wide-range drivers; 2395 & 2390 horns; 2405 UHF drivers, all crossovers, cycle cards, cabling & accessories. Three full systems, best offer one or more. **(212) 757-9086.**

WANT TO GO BI-AMP?

DeCoursey Electronic Dividing Networks are available from \$89.10 (monaural bi-amp) to \$205 (stereo tri-amp). Price includes plug-in Butterworth filters; 6, 12, or 18 dB per octave at any desired cut-off frequency. Write for brochure. **DeCoursey Engineering Laboratory, 11828 Jefferson Blvd., Culver City, Ca. 90230.**

MIXER MODULES: modular construction provides economical route to studio-type mixing console; modules available with mic/line, pan, echo send, plastic element slide faders; equalization is also available as an add-on module. Typical cost of 6-in, 2-out mixer (no EQ) is less than \$450.00. Send for catalog: **Wall of Sound, 2406 Mountain Rd., Pasadena, Md. 21122.**

SCULLY 1/4"-1/2"-2" RECORDERS, immediate delivery; console kits, 16/2, \$2,995.00, 16/4, \$3,295.00, 16/16, \$5,495.00, W/E.Q., available wired. All electronics, modular plug-in, Spectra-Sonic cards. **Stereotronic Industries Inc. (since 1940), 700-29th St., Zion, Ill. 60099. (312) 336-2222.**

DYMA builds custom studio consoles, desks, enclosures, studio furniture. **Dyma Engineering, Route 1, Box 51, Taos, New Mexico 87571.**

CASSETTE LABELS, blank and custom printed. Free samples. **Tarzac, 638 Muskogee Ave., Norfolk, Va. 23509.**



CATV—MATV PRODUCTS

- CONNECTORS
- WALLPLATES
- SPLITTERS
- AMPLIFIERS



AVA ELECTRONICS CORP.
242 Pembroke Avenue, Lansdowne, Pa. 19050
(215) 284-2500

NEW YORK'S LEADING PRO AUDIO/VIDEO DISTRIBUTOR for audio, video, broadcast, public address, and hi-fi systems; representing over 130 audio/video manufacturers, featuring such names as Ampex, Scully, Tascam, Sony, J. B. Lansing, Neumann, Altec, McIntosh, AKG, Dynair, T.V. Microtime, UREI, 3M, and other major brands; the largest "in stock" inventory of equipment, accessories, and parts; competitive discount prices; factory authorized sales, service, parts, systems design, installation. Write for free catalog! **Martin Audio/Video Corporation, 320 W. 46th St., New York, N.Y. 10036. (212) 541-5900.**

SPLICE TAPE FASTER, BETTER, BY SHEARING. Experts recommend Nagy splicers. Quality long-lasting instrument. Reasonably priced. Details, **NRPD, Box 289, McLean, Va. 22101.**

EMS SYNTHESIZERS. Find out how you can save money on EMS systems. We promise it's worth your while. Write **EMSA, 460 West St. (S), Amherst, Mass. 01002.**

REELS AND BOXES, 7" and 5" large and small hubs; heavy duty white boxes. **W-M Sales, 2010 Balboa, Dallas, Texas 75224.**

SCULLY 16-TRACK (288-16); very good condition, new record and play heads, with relapped replacement play head, \$12,500. **Cookhouse Recording Studios, 2541 Nicollet Ave., Minneapolis, Minn. 55404, (612) 827-5441.**

SENNHEISER MKH-105 condenser microphones; factory-calibrated pair, \$650; two AKG C-414 condenser microphones with N46E power supply, \$850; Beyer M-360 ribbon microphone, \$150.; all in mint condition. **Mark Plourd, 11760 SW 98th St., Portland, Oregon 97223. (Weekends) 1-503-639-7787.**

STUDIO SOUND—Europe's leading professional magazine. Back issues available from June, '73. \$1 each, postpaid. **3P Recording, P.O. Box 99569, San Francisco, Ca. 94109.**

KING MODEL 800S TAPE WINDER (hub); pre-recorded tape winder, will wind either 1/4 in. or 150 mil. widths; as new condition. Also used Rangertone resolver, as is. **Gary E. Taylor, Continental Film Productions Corp., P.O. Box 6543, Chattanooga, Tenn. 37408.**

DYMA builds roll-around consoles for any reel-to-reel tape recorder. **Dyma Engineering, Route 1, Box 51, Taos, New Mexico 87571.**

FREE CATALOG & AUDIO APPLICATIONS



- CONSOLES
- KITS & WIRED
- AMPLIFIERS
- MIC., EQ, ACN,
- LINE, TAPE, DISC,
- POWER
- OSCILLATORS
- AUDIO
- TAPE BIAS
- POWER SUPPLIES

OPAMP LABS, INC.
1033 N. SYCAMORE AVE.
LOS ANGELES, CALIF 90038
(213) 924-2544

B.B.C. REFERENCE MONITORS, pre-equalized J. B. L./Altec monitors; Dahlquist phased arrays; I. M. F. transmission lines; Infinity electrostatics; Crown/McIntosh 16 Ω/bridged bi-amps; Scully/Revox A-700 recorders; Micmix reverbs; Eventide phasors/omnipressors; Lexicon digital delays; dbx/Burwen N.R. companders; Little Dipper hum/buzz notch filters; Cooper Time Cube echo send; moving coil Supex/Ortofon; B & O straight line arms/cartridges; Schoeps/AKG/Sennheiser condensers; Beyer ribbons, U.R.E.I. comp/limiters/crossovers; Gately pro-kits; Q.R.K. tt. 1000s more. **Music & Sound Ltd., 11 1/2 Old York Rd., Willow Grove, Pa. 19090. (215) 659-9251.**

→ All Shipped Prepaid + Insured →

SINGLE EDGE RAZOR BLADES, tape editing. \$23/M. Flyer. **RALTEC, 25884 Highland, Cleveland, Ohio 44143.**

BODE FREQUENCY SHIFTERS since 1963... Advanced designs for electronic music studios and high performance P.A. systems. Synthesizer compatible model with built-in B.F.O., exponential interface, \$995.00. Anti-feedback model: audio range 35 Hz-16 kHz for speakers, entertainers, bands, \$575.00. Prices f.o.b. North Tonawanda. Delivery: stock to 6 weeks. For details and information on other models, write to: **Bode Sound Co., Harald Bode, 1344 Abington Place, N. Tonawanda, N.Y. 14120. (716) 692-1670.**

CUSTOM CROSSOVER NETWORKS to your specifications: 1 or 1000. Power capacities to 1,000 watts. Networks duplicated. High tolerance air and iron core inductors. Outline your needs for rapid quotation. **TSR ENGINEERING, 3673 W. 113th St., Inglewood, Ca. 90303. (213) 678-1979.**

WANTED

WANTED: PORTABLE DUAL TURN-TABLE, low cost. **E. Lewy, 853 N. Eutaw St., Baltimore, Md. 21201.**

WANTED: IONOVAC (DUKANE) tweeters; state condition and price. **Mark Plourd, 11760 S.W. 98th St., Portland, Oregon 97223.**

EMPLOYMENT

PROFESSIONAL RECORDING PERSONNEL SPECIALISTS. A service for employers and job seekers. Call today! **Smith's Personnel Service, 1457 Broadway, N.Y.C. 10036. Alayne Spertell. (212) WI 7-3806.**

WANTED: EXPERIENCED SENIOR RECORDING ENGINEER with solid following to join forces with growing top quality studio. Terms: negotiable. Contact: **Jerry Kornbluth, A&J Audio Visual Services, 119 W. 57th St., New York, N.Y. 10019.**



DAVIS



BARGER



SCHNEPP

● **Don Davis**, president of **Synergetic Audio Concepts** and well known for his teaching seminars, will conduct a series of mini-seminars at the **NEW-COM '75** show. The show will run from May 6-8 at the Las Vegas Convention Center. Mr. Davis' seminars will cover the basics to be mastered in order to understand room equalization and the more involved area of choosing workable systems and techniques. In addition to exhibits by the major professional sound and video products manufacturers, there will be displays by others in allied fields. Free badge application forms may be requested from **Electronic Industry Show Corp.**, 22 South Riverside Plaza, Chicago, Ill. 60606.

● Appointment of **Robert H. F. Lloyd**, as group director of MOS/LSI systems has been announced by **National Semiconductor Corp.**, of Santa Clara, Ca. Mr. Lloyd was the founder of **Advanced Memory Systems, Inc.** and served as their chief executive officer before coming to National Semiconductor. He holds four patents and is the author of six technical publications.

● **Sanyo Electric Inc.** of Compton, Ca. has appointed the **Leonard Elliott Company** as its manufacturer's representative in the southeast area, including Tennessee, Mississippi, Alabama, Georgia, and N. and S. Carolina. The Elliott Company is located in Atlanta, Georgia.

● **James E. Patterson** has been promoted to national accounts manager of audio bulk products for **BASF Systems**, of Bedford, Mass. He will be responsible for national sales and related activities in marketing the company's blank cassette duplicating products. Mr. Patterson, who has been

with **BASF** since 1973, was formerly associated with the **Savin Business Machine Co.**

● **Herman C. Barger** has been appointed eastern regional sales manager for **TDK Electronics Corp.**, of Garden City, N.Y. Mr. Barger will be responsible for sales of TDK products in 20 states in the eastern part of the U.S. Before joining TDK, Mr. Barger was with the **Capitol Records Company**.

● Filling the newly created position of director of corporate communications at **Superscope**, of Sun Valley, California, **Harley R. Gleckman** will act as a liaison between the company and the financial community. Another position, also in the realm of corporate communications, manager of corporate communications, has been filled by **Elyn Rankell**. An additional new appointment at Superscope is that of **Ned Padwa** to the position of general manager, tape duplicating division. New regional vice-presidents have been recently announced: **Mario Cannata**, New England; **Joseph Deo**, New York; **Richard Isola**, Detroit; **Robert Neuhaus**, Southwest; **David Pedrick**, Northwest.

● **Harro K. Heinz** has been appointed president of the **Rauland-Borg Corp.** of Chicago. **Mr. E. N. Rauland** will continue, as chairman of the board, and chief executive officer. Mr. Heinz has been with Rauland-Borg for a year. Previously, he was associated with **Bogen and Fisher Radio**.

● Several new appointments have been announced by the **TEAC Corporation**, of Montebello, Ca. **Masa-kasu Sekine** has been named video sales coordinator for the American

company. He was formerly employed by **TEAC** in Japan. **Jorge Montero** has been selected to coordinate increasing sales activity in Latin America. Mr. Montero, who is a native of Ecuador, was formerly associated with **Audio Magnetics**.

● **Richard D. Schnepf** has been named vice president of commercial/professional sales for **Jack Carter Associates** of N. Hollywood, Ca. Mr. Schnepf has been with the organization for the past nine years.

● A revised and updated third edition of the **FM ATLAS AND STATION DIRECTORY** is now available from **FM Atlas**, Box 24, Adolph, Minn. 55701, at a cost of \$2.50. Some 4000 f.m. stations are listed from Panama to Greenland. Data are given on individual stations' formats, powers, heights, stereo capability, vertical polarization, frequencies and call letters. The directory also lists network and affiliations and stations having a 67 kHz SCA and what they actually program on this channel. Also included are outline maps showing f.m. cities and frequencies of North America. The directory was prepared by **Bruce F. Elving**.

● **Sudden Rush Music**, of the Bronx, N.Y. has initiated a new service. They will supply studio quality artists, readers and non-readers, for session work at both union scale for mastering and at a special reduced rate for all demo and production/spec work. Musicians are available on instruments ranging from harmonica to vibes to synthesizer, capable of producing rock, pop, soul, and country music. Musicians experienced in translating a composer or producer's concepts to the fingering and style of their instruments are available. Information can be obtained from **Michael Berman** at Sudden Rush Music, 750 Kappock St., Bronx, N.Y. (212) 884-6014.

● Two engineering department executives have been promoted by **Shure Brothers, Inc.** of Evanston, Ill. **Bernhard Jakobs** has been named director of development and application engineering, directing all activities of the engineering services department. **Donald Patten** has been appointed manager of engineering services, responsible for application engineering activities, including data sheet and booklet preparation.

A-7300

**Just
because
we don't
call it
professional
doesn't
mean it
couldn't be.**

We don't call our A-7300 a professional tape recorder — we make those too, and we know the difference.

On the other hand, the A-7300 is far better than the typical high fidelity component. Consider, for example, some of the professional features... a servo controlled direct drive capstan system, full IC logic transport controls, four balanced mic inputs with XL-type connectors, a flip-up hinged head cover for easy maintenance and editing.

Yet, in the final analysis, it isn't what it's called, but what it does that counts. You'll have to determine for yourself whether or not it meets your specific needs, and you can do that only by examining and operating it for yourself.

You'll find that our retailers are well informed and helpful in general. Rare qualities, so there can't be many of them. You can find the one nearest you by calling (800) 447-4700.* We'll pay for the call.

*In Illinois, call (800) 322-4400.

TEAC

The leader. Always has been.

TEAC Corporation of America,
7733 Telegraph Road,
Montebello, California 90640.



COME TO THE REVOLUTION!

At the 51st AES Convention in L.A., May 13-16, Automated Processes will demonstrate a radically new concept in Audio Mixing...

A Completely Programmable Mixdown Console called AUTOMIX.

Automix as a manual mixdown console is incomparable. As a programmable console, it permits new standards of perfection and artistry.

You may capture every detail and nuance of a mix from up to 32 inputs and 4 echo channels. When programmed, your mix may be precisely repeated as often as desired, or each element of sound on any track may be improved individually or in combination.

The audio paths are entirely separated from the DC control circuits. Voltage control amplifiers and state variable devices in the audio paths provide for all functions: level, localization, reverberation, and equalization. Control of multiple audio paths by a

single manipulator (grouping) is possible for all functions. An optional video screen displays the quad sound field, identifying each input, as a numeral, in its respective aural position.

Extraordinary performance is achieved at a very ordinary price. Automix, even with a companion Automated Processes' studio mixing console, can be obtained at substantially lower cost than a conventional console of comparable numerical capabilities.

Be sure to see AUTOMIX in "hands-on" action at the AES Convention. Visit Automated Processes' Demo Rooms 474/76, on the 4th floor of the L.A. Hilton!

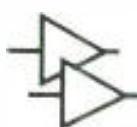

AUTOMATED PROCESSES, INC.
80 MARCUS DRIVE, MELVILLE, NEW YORK 11746 • 516-694-9212

Circle 11 on Reader Service Card